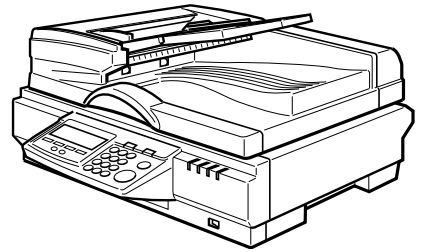



Image Scanner

Operating Instructions



-
- 1** What You Can Do With This Machine
 - 2** Setting Up the Scanner
 - 3** Configuring the Scanner Settings
 - 4** Setting Originals
 - 5** Using the Network TWAIN Scanner Function
 - 6** Sending Scan File by E-mail
 - 7** Sending Scan File by Scan to Folder
 - 8** Sending Scan File by Scan to FTP
 - 9** Sending Scan Files Using Delivery Server
 - 10** Printing Scanned Image Files
 - 11** Appendix

Read this manual carefully before you use this product and keep it handy for future reference. For safe and correct use, please be sure to read the Safety Information in this manual before using the machine.

Introduction

This manual describes detailed instructions on the operation and notes about the use of this machine. To get maximum versatility from this machine all operators are requested to read this manual carefully and follow the instructions. Please keep this manual in a handy place near the machine.

Power Source

Colour Scanner: 220 - 240V, 50/60 Hz, 5A or more

Please be sure to connect the Power Cord to a power source as above.

Two kinds of size notation are employed in this manual. With this machine refer to the metric version.

Important

Contents of this manual are subject to change without prior notice. In no event will the company be liable for direct, indirect, special, incidental, or consequential damages as a result of handling or operating the machine.

The supplier shall not be responsible for any damage or expense that might result from the use of parts other than genuine parts from the supplier with your office products.

Certain options might not be available in some countries. For details, please contact your local dealer.

Some illustrations in this manual might be slightly different from the machine.

TABLE OF CONTENTS

Trademarks	1
Safety Information	2
Safety During Operation.....	2
Lithium Batteries (Memory Back-up).....	3
Manuals for This Scanner	4
Manuals for This Scanner	4
How to Read This Manual	5

1. What You Can Do With This Machine

Outline	7
Network TWAIN Scanner	7
Scan to E-mail.....	8
Scan to Folder.....	9
Scan to FTP	10
Scan to Print.....	11
Delivery Server.....	12
Guide to this Scanner	13
Using Keys Displayed on the Screen.....	15
How to Interpret the Indicators	16
Front indicators.....	16
Network interface indicators	17
Function Settings and Standby Screens	17
Function Priority.....	18
Select Method.....	19
Standby screens.....	19
Scanner Features Menu.....	21

2. Setting Up the Scanner

Checking the Scanner Location	23
Attaching the Control Panel Unit to the Scanner Unit	25
Connecting to a Local Printer	26
Setting Up the Optional Accessories	28
Installing the Image Processing Unit.....	28
Inserting a Wireless LAN Card.....	29
Connecting to a Network	30
Connecting to a Power Source	31

3. Configuring the Scanner Settings

Outline to Use As a Network Twain Scanner	33
Outline to Use Scan to E-mail	34
Outline to Use Scan to Folder	35
Outline to Use Scan to FTP	37
Outline to Use the Network Delivery	38
Outline to Use Scan to Print	40
Initial Scanner Setup	41

System Settings	52
Information to Set in [System Settings].....	52
Configuring [System Settings]	55
Scanner Settings	59
Information to Set in [System Settings].....	59
Configuring [Send Scan Settings]	64
Print Scan Settings	67
Information to Set in [Print Scan Settings].....	67
Configuring [Print Scan Settings]	67
Registering Scan Settings	70
Information to Register in [Send Scan Settings]	70
Registering [Scan Settings]	74
Registering Print Settings	79
Information to Register in [Print Settings]	79
Registering [Print Settings]	80
Configuring Settings Using a Web Browser	84
Accessing the Scanner	84
System requirements of a client computer	84
To access this machine from a web browser	85
General guide to the Web Status Monitor	86
Example Procedures Using [Configuration] Main Menu	87
Configuring [Scan Settings]	87
Configuring [E-mail Address]	88
Information to Register as Destination and Printer	91
Information to register in [E-mail Address].....	91
Information to register in [File Send Path]	92
Information to register in [FTP Server].....	94
Information to register in [Printer].....	96
Recalling the Settings	98
To recall the settings	98
Creating a Backup File of All the Settings.....	99
Setup items to be backed-up and restored.....	99
To create a backup file	99
To restore settings from a backup file	100
Installing Software	102
List of Files	102
Auto Run Program	102
Software for Using a Network TWAIN Scanner	103
System requirements.....	103
Using Windows 95/98/Me, Windows XP, Windows 2000, or Windows NT 4.0	103
Software for Using the Network Delivery Scanner Function	104
System requirements.....	104
DeskTopBinder V2 Lite	105
System requirements.....	105
SmartDeviceMonitor.....	106
About SmartDeviceMonitor for Admin and SmartDeviceMonitor for Client	106
Installing SmartDeviceMonitor.....	107

4. Setting Originals

Sizes and Weights of recommended Originals	109
The Original Sizes Available for Auto Detection	110
Originals that Require Special Care	111
Original Orientation	112
Simplex Scanning	113
Settings for Print Scan in simplex scanning	114
Duplex Scanning	114
Settings for Print Scan in duplex scanning	115
Placing the Original on the Exposure Glass.....	116
Placing the Originals in the ADF	117

5. Using the Network TWAIN Scanner Function

Procedure Breakdown	119
Scanning Originals	120
Functions of the TWAIN Driver	122

6. Sending Scan File by E-mail

Procedure Breakdown	123
E-mail Content	124
Sender	124
Subject.....	124
File name and file type of an e-mail attachment.....	124
Related information	124
Before Sending Scan Data	126
Original Location	126
Original Orientation and Scanning Sides	126
E-mail/Send File standby screen	126
Selecting Destinations and a Subject	128
Selecting Destinations.....	128
Selecting Cc Destinations	130
Selecting a Subject	130
Making Scan Settings	132
Confirming the Scan Settings.....	133
Selecting a Sender	134
Performing Scan Operation	135
Starting a Scan Operation.....	135
To start with originals in the ADF.....	135
To start with an original on the exposure glass	136
Checking Transmission Results.....	137

7. Sending Scan File by Scan to Folder

Sending a Scanned File to a Registered Shared Folder	139
Procedure Breakdown.....	139
Selecting a Shared Folder.....	140
Selecting a File Name	142

Using [Enter Custom Send File] to Send a Scanned File to an Unregistered Shared Folder	143
Procedure Breakdown.....	143
Using the Enter Custom Send File Function	144
Scanned Image Files Sent to Shared Folders	147
File Locations	147
File Names	147

8. Sending Scan File by Scan to FTP

Procedure Breakdown.....	149
Selecting an FTP Server.....	150
Scanned Image Files Sent to FTP Servers	152
File Locations	152
File Names	152

9. Sending Scan Files Using Delivery Server

Procedure Breakdown.....	155
Selecting Delivery Destinations	156

10. Printing Scanned Image Files

Procedure Breakdown.....	159
Before Printing Scan Data.....	160
Original Locations	160
About Paper Tray Settings	160
About Print Scan Standby Screen.....	160
Printing Scan Data	162
Specifying the Number of Copies.....	163
Configuring Print Settings	163
Confirming the Print Settings	165
Selecting a Printer	166
Selecting Colour/Black and White	167

11. Appendix

Troubleshooting.....	169
Error Indicators.....	169
When the Machine does not Work as Expected	170
When Scanning is Not Performed as Expected	171
When an Error Message Appears.....	172
Scanner unit error message	172
Scan settings error messages.....	173
Send Scan (E-mail, Send File (SMB/FTP) or Delivery Server) operation error messages	175
Print Scan operation error messages	176
Error messages displayed on the Web Status Monitor	177
Other Problems	178
Cleaning.....	180
Cleaning the Exposure Glass, ADF Exposure Glass, White Sheet, and White Plate	180
Cleaning the Feed Roller	181
Cleaning the Document Roller	181
Cleaning the Document Rolling Unit	182

Moving and Transporting the Scanner	183
Moving Over Short Distance	183
Transporting the Scanner.....	184
Disposing of the Scanner.....	185
Using Wireless LAN.....	186
Outline to Use Wireless LAN.....	186
Configuring Wireless LAN Settings	186
E-mail Address Book Data Format and Device Tag Information.....	191
Entered Program Information.....	191
About the e-mail address information.....	192
Device Tag Information	193
How File Size Changes Depending on Scan Area and Resolution	194
When Using this Machine as a Network TWAIN Scanner	194
When [Binary] or [Halftone] is selected	195
When [Gray-scale] is selected.....	196
When [8 colors] or [8 colors (halftone)] is selected	197
When [256 colors] is selected	198
When [16770K colors] is selected.....	199
When Using this Machine for Sending Scan Data	199
When [Black and White: Text] , [Black and White: Text/Photo] or [Black and White: Photo] is selected.....	200
When [Black and White: Gray Scale] is selected	200
When [Color: Full Color] is selected	201
Options	202
Specifications.....	203
Software Information	205
GPL/LGPL Application Software	205
BSD License Application Software	205
The Apache Software License Application Software	206
JPEG Software	207
TIFF Software	208
UCD-SNMP Software.....	209
MD5 Software License Agreement	211
Expat.....	211
INDEX.....	212

Trademarks

Adobe, PostScript, and Acrobat are trademarks of Adobe Systems Incorporated. Pentium is a registered trademark of Intel Corporation.

MS, Microsoft, and Windows are registered trademarks of Microsoft Corporation.

Other product names used herein are for identification purposes only and might be trademarks of their respective companies. We disclaim any and all rights to those marks.

- The product name of Windows[®] 95 is Microsoft[®] Windows[®] 95
- The product name of Windows[®] 98 is Microsoft[®] Windows[®] 98
- The product name of Windows[®] Me is Microsoft[®] Windows[®] Millennium Edition (Windows Me)
- The product names of Windows[®] 2000 are as follows:
 - Microsoft[®] Windows[®] 2000 Professional
 - Microsoft[®] Windows[®] 2000 Server
 - Microsoft[®] Windows[®] 2000 Advanced Server
- The product names of Windows[®] XP are as follows:
 - Microsoft[®] Windows[®] XP Home Edition
 - Microsoft[®] Windows[®] XP Professional
- The product names of Windows Server[™] 2003 are as follows:
 - Microsoft[®] Windows Server[™] 2003 Standard Edition
 - Microsoft[®] Windows Server[™] 2003 Enterprise Edition
 - Microsoft[®] Windows Server[™] 2003 Web Edition
- The product names of Windows[®] NT 4.0 are as follows:
 - Microsoft[®] Windows NT[®] Workstation 4.0
 - Microsoft[®] Windows NT[®] Server 4.0

Safety Information

When using this machine, the following safety precautions should always be followed.

Safety During Operation

In this manual, the following important symbols are used:

 **WARNING:**
Indicates a potentially hazardous situation which, if instructions are not followed, could result in death or serious injury.

 **CAUTION:**
Indicates a potentially hazardous situation which, if instructions are not followed, may result in minor or moderate injury or damage to property.

WARNING:

- Connect the Power Cord directly into a wall outlet and never use an extension cord.
- Disconnect the power plug (by pulling the plug, not the cable) if the power cable or plug becomes frayed or otherwise damaged.
- Turn off the power and disconnect the power plug (by pulling the plug, not the cable) if any of the following conditions exists:
 - You spill something into the equipment.
 - You suspect that your equipment needs service or repair.
 - Your equipment's cover has been damaged.
- Disposal can take place at our authorized dealer or at appropriate collection sites.

CAUTION:

- Protect the equipment from dampness or wet weather, such as rain, snow, and so on.
- Unplug the Power Cord from the wall outlet before you move the equipment. While moving the equipment, you should take care that the Power Cord will not be damaged under the equipment.
- When you disconnect the power plug from the wall outlet, always pull the plug (not the cable).
- Do not allow paper clips, staples, or other small metallic objects to fall inside the equipment.
- For environmental reasons, do not dispose of the equipment or expended supply waste at household waste collection points. Disposal can take place at an authorized dealer or at appropriate collection sites.
- The inside of the machine could be very hot. Do not touch the parts with a label indicating the "hot surface". Otherwise it could cause a personal burn.
- Our products are engineered to meet high standards of quality and functionality, and we recommend that you only use the expendable supplies available at an authorized dealer.

Lithium Batteries (Memory Back-up)

 **WARNING:**

- Do not try to replace the lithium batteries by yourself. A battery of this type can explode if incorrectly replaced. If the lithium batteries need to be replaced, contact an authorized dealer to request servicing.
- Never dispose of the lithium batteries by incineration. This can cause them to rupture resulting in injury.

 **Note**

- Please return used NIC boards to our authorized dealer or service representative. Your cooperation with our recycling activities is appreciated.
- NIC boards are equipped with a lithium battery. In the case NIC boards are disposed of by the customer, please dispose them in accordance with national or local regulations after separating the lithium batteries from the NIC board.

Manuals for This Scanner

Manuals for This Scanner

The following manuals describe the operational and maintenance procedures of this machine.

To enhance safe and efficient operation of this scanner, all users should read and follow the instructions carefully.

❖ **Quick Installation Guide**

Describes how to install the scanner.

❖ **Operating Instructions (this manual)**

Provides all of the information how to install, set up, and use the scanner. This manual is provided as a PDF file.

 **Note**

There is a CD-ROM that comes with this scanner.

How to Read This Manual

Symbols

The following set of symbols is used in this manual.

 **WARNING:**

This symbol indicates a potentially hazardous situation that might result in death or serious injury when you misuse the machine without following the instructions under this symbol. Be sure to read the instructions, all of which are described in the Safety Information section.

 **CAUTION:**

This symbol indicates a potentially hazardous situation that might result in minor or moderate injury or property damage that does not involve personal injury when you misuse the machine without following the instructions under this symbol. Be sure to read the instructions, all of which are described in the Safety Information section.

* The statements above are notes for your safety.

 **Important**

If this instruction is not followed, paper might be misfed, originals might be damaged, or data might be lost. Be sure to read this.

 **Preparation**

This symbol indicates information or preparations required prior to operating.

 **Note**

This symbol indicates precautions for operation, or actions to take after abnormal operation.

 **Limitation**

This symbol indicates numerical limits, functions that cannot be used together, or conditions in which a particular function cannot be used.

 **Reference**

This symbol indicates a reference.

[]

Keys that appear on the machine's display panel.

[]

Keys and buttons that appear on the computer's display.

[]

Keys built into the machine's control panel.

[]

Keys on the computer's keyboard.

1. What You Can Do With This Machine

This section introduces various functions of this machine, and provides most basic information such as control locations and standby screens, etc.

Outline

Network TWAIN Scanner

You can use this machine as a network TWAIN scanner, by operating this machine from a client computer on the network. Originals can be scanned with the same operation used for SCSI- and USB-connected scanners.

By sharing this scanner by a number of computers, there is no trouble of allocating a special computer for scanning, or connecting a scanner to a computer each time you need.

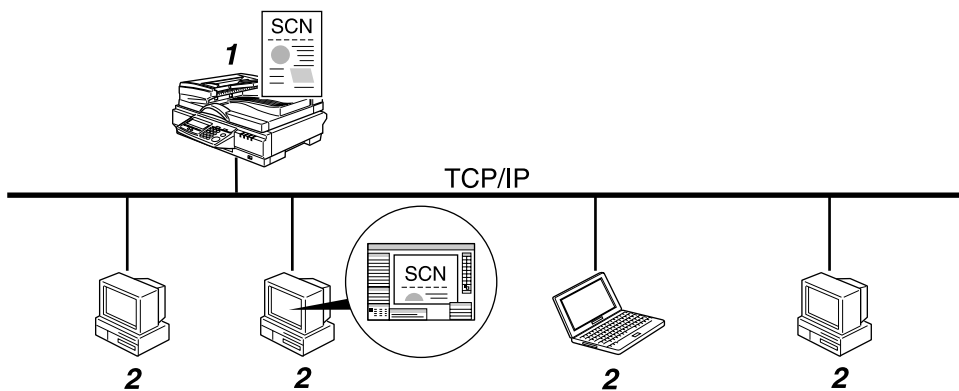

1. This machine

Connect this machine to a network (TCP/IP) using a 100BASE-TX or 10BASE-T cable. It is possible to connect using an optional wireless LAN card.

2. Client computer

The scanner can be operated using a TWAIN-compliant application (such as DeskTopBinder V2 Lite).

Process Flow

- 1** Use a TWAIN-compliant application on a "2.Client computer" to send a command for scanning via the network TWAIN driver.
- 2** Originals are scanned by "1.This machine."
- 3** The scan data can be edited and stored using the TWAIN-compliant application on the "2.Client computer."

Scan to E-mail

By registering e-mail addresses on this machine, you can use this machine to generate an e-mail message and send a scan file as an e-mail attachment.

1

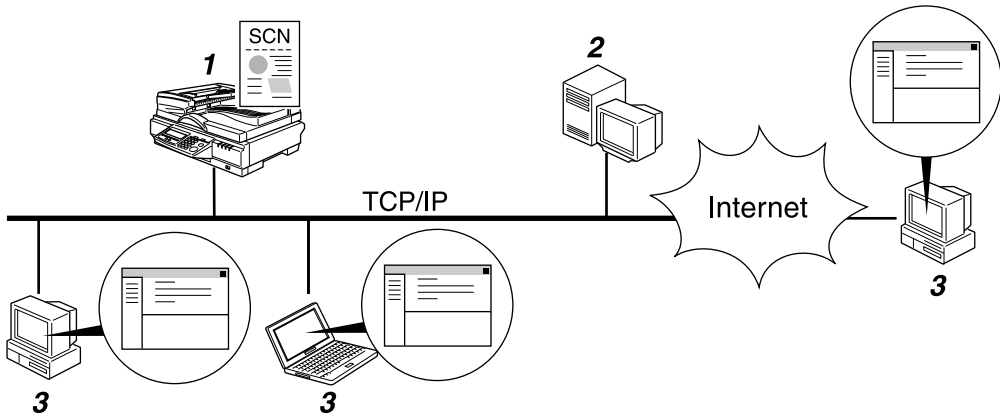

1. This machine

Connect this machine to a network (TCP/IP) using a 100BASE-TX or 10BASE-T cable. It is possible to connect using an optional wireless LAN card.

2. SMTP server

You need to have an access to an e-mail server that supports SMTP (Simple Mail Transfer Protocol), to use "Scan to E-mail" function. However, it is not essential to have an e-mail server inside the LAN where this machine belongs.

3. E-mail client software

Use e-mail client software (such as Microsoft Outlook) to receive e-mail messages and scan file attachments that are generated by this machine.

Process Flow

- 1** Specify an e-mail destination, subject, and make necessary settings for scanning using the control panel of "1.This machine."
- 2** Originals are scanned by "1.This machine."
- 3** An e-mail message with a scan file attachment is sent to "2.SMTP server" from "1.This machine."
- 4** The e-mail message is delivered to the specified destination's POP server from "2.SMTP server", and received by "3.E-mail client software".

Scan to Folder

It is possible to register Windows shared folders to this machine, as destinations for sending scan data. You can easily send and save scan files to a Windows shared folder that is registered to this machine.

Note

- ❑ This function is displayed as “Send File: SMB” on the display panel of this machine. The SMB (Server Message Block) standard, to which various operating systems including Windows adhere, is a popular protocol for sharing files, folders, printers and so on.

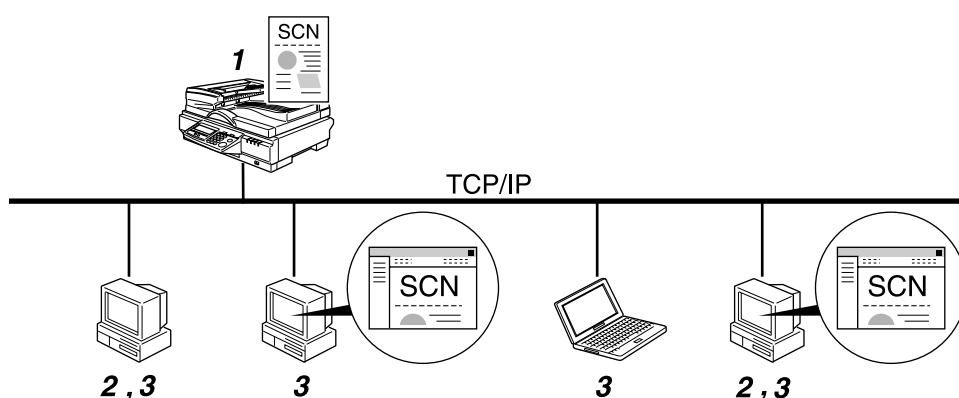

1. This machine

Connect this machine to a network (TCP/IP) using a 100BASE-TX or 10BASE-T cable. It is possible to connect using an optional wireless LAN card.

2. Computer with a shared folder

To use this function, it is necessary to create a shared folder in advance. You can specify a shared folder to save scan files.

3. Client computer

You can use a client computer on the network to perform a scan to folder operation remotely (which requires a Web browser). You can also browse scanned files saved to a shared folder from a client computer.

Process Flow

- 1** Specify a shared folder, file name, and make necessary settings for scanning using “3.Client computer”, or the control panel of “1.This machine.”
- 2** Originals are scanned by “1.This machine.”
- 3** The scan data is saved in the specified shared folder on “2.Computer with a shared folder”.
- 4** You can use the scan data from “3.Client computer”.

Scan to FTP

1

It is possible to register FTP servers to this machine as destinations for sending scan data. You can easily send and save scan files to an FTP server that is registered to this machine.

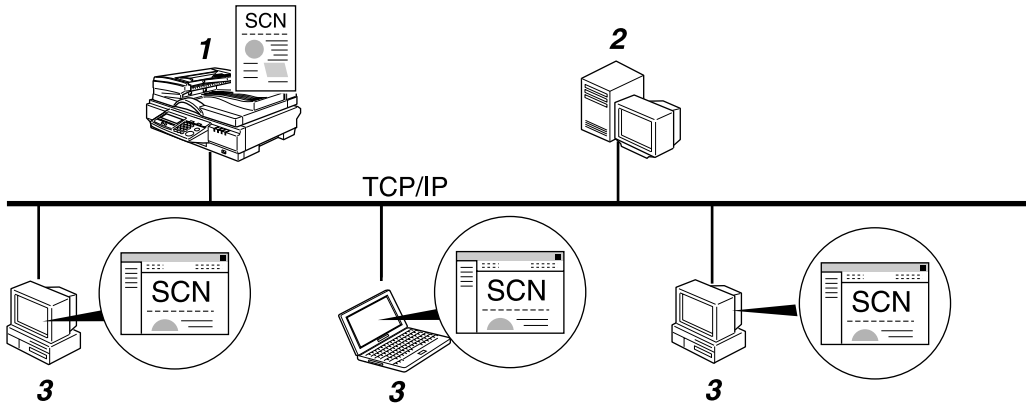

1. This machine

Connect this machine to a network (TCP/IP) using a 100BASE-TX or 10BASE-T cable. It is possible to connect using an optional wireless LAN card.

2. FTP server

You can specify an FTP server to save scan files. Note, however, that it is essential to have the FTP server inside the LAN/WAN where this machine belongs. It is not possible to access an FTP server via a proxy server.

3. Client computer

You can browse scanned files saved to an FTP server from a client computer. You need to have an FTP client program on the computer to connect to an FTP server.

Process Flow

- 1** Specify an FTP server, file name, and make necessary settings for scanning using the control panel of "1.This machine."
- 2** Originals are scanned by "1.This machine."
- 3** The scan data is saved in the specified folder on "2.FTP server".
- 4** You can use the scan data from "3.Client computer".

Scan to Print

You can send scan files directly to a printer, so it is possible to use this machine like a copier.

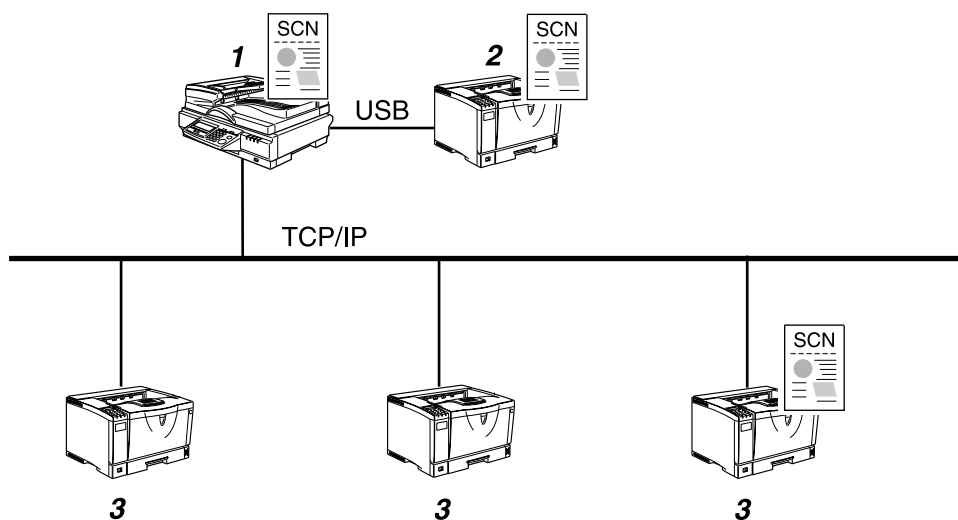

1. This machine

When you use a network printer, connect this machine to a network (TCP/IP) using a 100BASE-TX or 10BASE-T cable. It is possible to connect using an optional wireless LAN card.

2. Local printer

A printer connected to this machine using a USB cable.

3. Network printers

Printers connected to a network (TCP/IP) using a 100BASE-TX or 10BASE-T cable. It is necessary to assign a fixed IP address to each of the network printers.

Process Flow

- 1** Perform a Print Scan operation using the control panel of "1. This machine."
- 2** Originals are scanned by "1.This machine."
- 3** The scan data is interpreted to a printer language and sent to either "2.Local printer" or one of "3.Network printers" you specified.
- 4** The scan data is printed from the printer (either "2.Local printer" or one of "3.Network printers") you specified.

Delivery Server

By using ScanRouter V2 Professional/Lite, it is possible to deliver scan data that is scanned by this machine to multiple destinations.

1

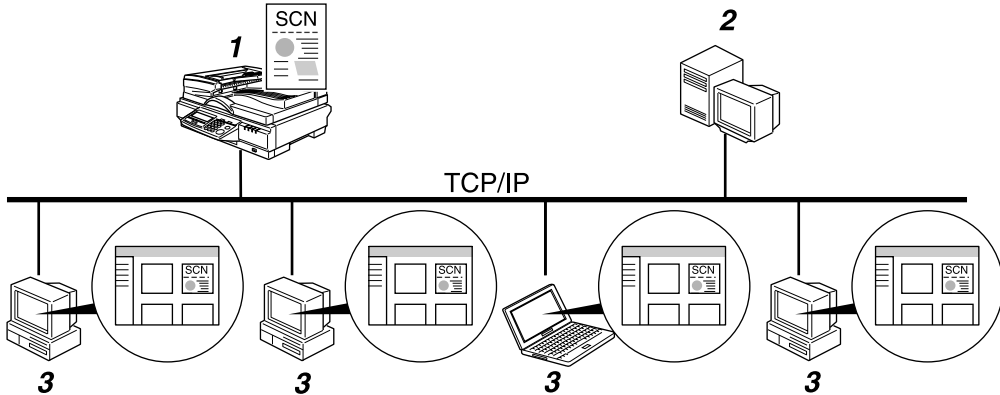

1. This machine

Connect this machine to a network (TCP/IP) using a 100BASE-TX or 10BASE-T cable, or using an optional wireless LAN card. You can connect up to two machines to a network where you have a computer (a delivery server) with ScanRouter V2 Lite (that comes with this machine) installed.

2. Delivery server

A delivery server with ScanRouter V2 Professional/Lite installed, which manages destinations including e-mail addresses, shared folders, groups, etc., and document data files sorted by each of the destinations.

3. Client computer

You can browse document data files on a delivery server from a client computer, by using DeskTopBinder V2 Lite. You can also save those files on the local hard disk of the client computer, as necessary.

Process Flow

- 1** Specify destinations, and make necessary settings for scanning using the control panel of "1.This machine."
- 2** Originals are scanned by "1.This machine."
- 3** The scan data is sent to and saved on "2.Delivery server".
- 4** "2.Delivery server" performs jobs as configured, such as giving delivery notice to specified destinations, or storing the scan data on a specified hard disk, etc.
- 5** You can use the scan data from "3.Client computer" by using DeskTopBinder V2 Lite.

Guide to this Scanner

1

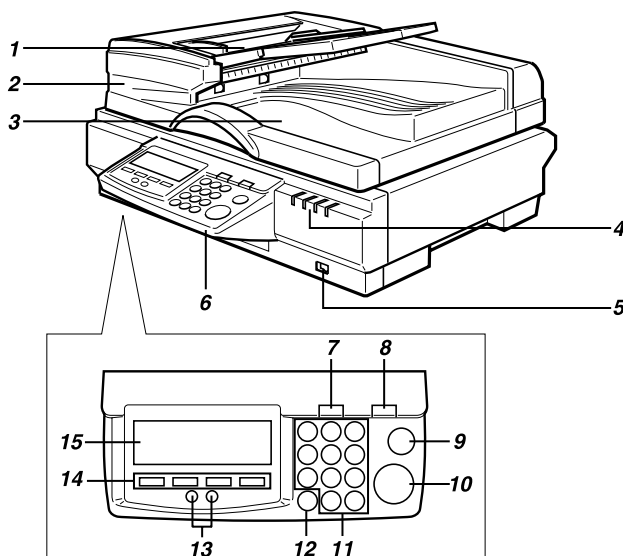

1. Original table

Set originals here to be loaded into this machine using the ADF (Automatic Document Feeder).

2. ADF (Automatic Document Feeder)

Allows you to automatically load multiple originals into this machine. The ADF also provides duplex scanning.

3. Output table

The originals that have been loaded by the ADF are output here after scanning.

4. Indicators

Indicate status of this machine.

5. Power switch

Turns this machine's power on and off.

6. Control panel

Used to configure settings and operate this machine.

7. [User Tools] key

Press this key to configure various settings such as send scan, print scan, network, etc.

8. [Clear Modes] key

Press this key to return to the initial screen that is displayed when you turn the power on.

9. [Clear/Stop] key

Press this key when you want to clear the value that you have entered, or stop scanning currently in progress.

10. [Start] key

Press this key to start scanning.

11. Number keys

Used to select a menu item displayed on the screen, or enter numeric values.

12. [/*] (Title) key

Press this key to display list of titles.

13. Cursor keys ([←] / [→] keys)

Used to move highlight on the screen for selecting an option.

14. Function key

Used to select functions that appear on the display panel of this machine. See p.15 "Using Keys Displayed on the Screen" for details.

15. Display panel

Displays a screen for scanning operations, settings or status information, along with keys that are currently available for the corresponding function key operations.

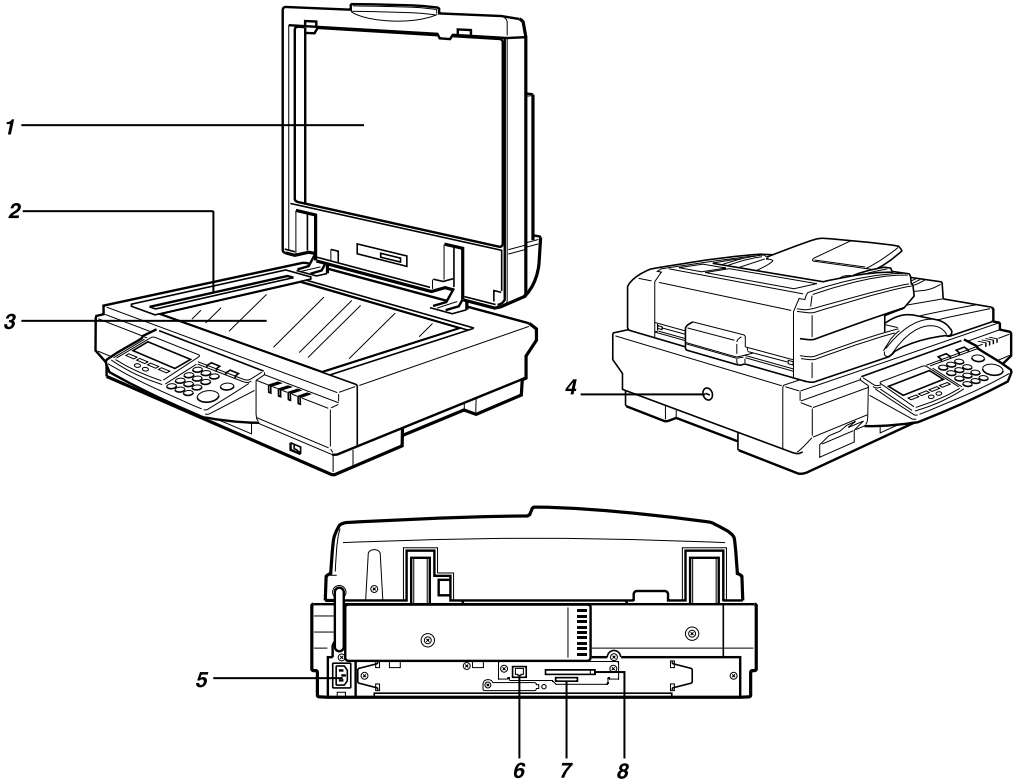

1. White Sheet

Holds the original down on the exposure glass.

2. Exposure glass for the ADF

Scans originals when they are loaded in the ADF.

3. Exposure glass

Place the original here when you do not use the ADF for scanning.

4. Lock switch

Set this switch to the “Lock” position when you transport this machine.

5. Power connector

For connection of the bundled AC power cord.

6. Network interface connector

For connection of an Ethernet network cable.

7. SD card slot

Used for an authorized customer engineer’s maintenance purpose only.

8. PC card slot

This machine has a Type II PC card slot. By inserting the USB interface card that comes with this machine to the slot and connecting a USB printer, you can use the printer as a local printer for Print Scan. You can also use the slot for an optional wireless LAN card, instead of the USB interface card.

Using Keys Displayed on the Screen

You can use the function keys, located under the display panel, to operate keys that appear on the display panel.

Example:

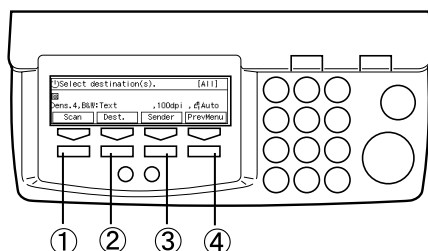

To execute a key operation on the display panel, press the relevant function key.

- Press ① to select **[Scan]**.
- Press ② to select **[Dest.]**.
- Press ③ to select **[Sender]**.
- Press ④ to select **[PrevMenu]**.

How to Interpret the Indicators

1 Front indicators

This section explains how to interpret the indicators of this machine.

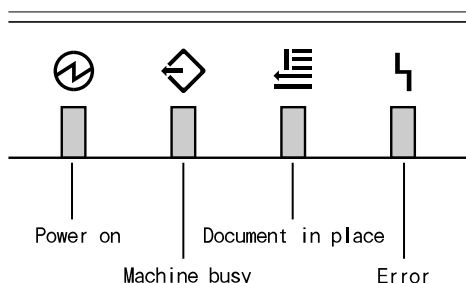

The following table shows the status of the indicators when this machine operates normally. If any of the indicators appear differently, it means an error. See p.169 "Error Indicators" to eliminate the error.

				Description
				For a short while after turning the power on
	—	—	—	Power is on No original is set to the original table No scanning operation is in progress
	—		—	Power is on Originals are set to the original table No scanning operation is in progress
		—	—	Power is on No original is set to the original table Scanning operation is in progress
			—	Power is on Originals are set to the original table Scanning operation is in progress
	—	—	—	Power save mode

⊙: On

○: Blinking

—: Off

Network interface indicators

The network interface connector on the rear panel of this machine is equipped with the following two indicators.

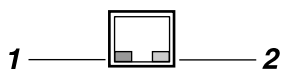

1. Green indicator

Lights when this machine is connected to the network correctly.

2. Yellow indicator

Lights when this machine is sending/receiving data through the network.

Function Settings and Standby Screens

You cannot use the following functions at the same time.

- Network TWAIN (See p.7 “Network TWAIN Scanner”)
- E-mail (See p.8 “Scan to E-mail”)
- Send File (SMB) (See p.9 “Scan to Folder”)
- Send File (FTP) (See p.10 “Scan to FTP”)
- Delivery Server (See p.12 “Delivery Server”)
- Print Scan (See p.11 “Scan to Print”)

To select the functions you use, you must configure the following settings in advance.

- With the options in **[7.Select Method]**, select a method that suits for the functions you want to use.
- With the options in **[Function Priority]** and **[1.Select Method]**, select the initial screen that is displayed when you turn the machine's power on.

Note

- **[1.Select Method]** and **[7.Select Method]** are menu items that are included in **[2.Send Scan Settings]** under Scanner Features menu, which is displayed by pressing the **[User Tools]** key. **[Function Priority]** is a menu item that is included in **[1.System Settings]** under Scanner Features menu.

Reference

p.59 “Scanner Settings” for details about how to configure the above settings.

Function Priority

You can select the initial screen displayed each time you turn the machine's power on. It is good idea to select the initial screen in accordance with how frequently you use Print Scan. The following three options are available.

- **Select: Send/Print**
Select this option if you use Print Scan as well as Delivery Server/Send File. On the Select Method screen (which is initially displayed when you select this option), pressing the **[1]** key displays the same screen as one of the Send Scan initial screens, and pressing the **[2]** key displays the same screen as the Print Scan initial screen.

 **Note**

- Instead of pressing the number keys, you can also use the **[4]** or **[6]** key to highlight "Send Scan" or "Print Scan" on the screen, and then press **[OK]**.

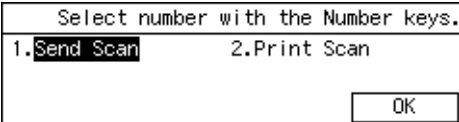

- **Send Scan**
Select this option if you hardly ever use Print Scan. With this option, one of the following screens is displayed as the initial screen, depending on the setting in **[7.Select Method]** :
Delivery Server standby screen, E-mail/Send File standby screen, or Network TWAIN standby screen

If you want to print scan data while a Send Scan initial screen is displayed, press **[PrevMenu]** to display the Select Method screen, and then press the **[2]** key.

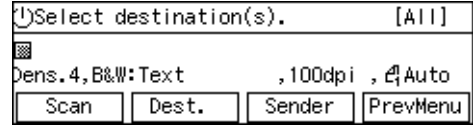

- **Print Scan**
Select this option if you use Print Scan frequently. With this option, the Print Scan standby screen is displayed as the initial screen. If you want to use any one of the functions other than Print Scan (Delivery server, e-mail, Send File or Network TWAIN) while the Print Scan standby screen is displayed, press **[PrevMenu]** to display the Select Method screen, and then press the **[1]** key. At this time, Delivery Server standby screen, E-mail/Send File standby screen, or Network TWAIN standby screen is displayed, depending on the settings in **[1.Select Method]** and **[7.Select Method]**.

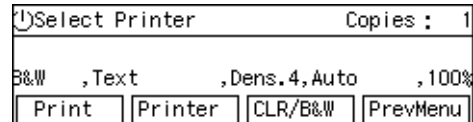

Select Method

There are two setup items named “Select Method”: **[1.Select Method]** and **[7.Select Method]**. Use these items in combination to configure how you use this machine.

- With the options in **[7.Select Method]**, you can select a combination of the functions that suits for the method how you use this machine. The following three options are available.
 - **Delivery Server/TWAIN**
Select this option if you want to use Delivery Server and network TWAIN. With this option, e-mail, Send File (SMB), and Send File (FTP) are not available.
 - **Send File/TWAIN**
Select this option if you want to use e-mail, Send File (SMB), Send File (FTP), and network TWAIN. With this option, Delivery Server is not available.
 - **TWAIN**
Select this option if you want to use Network TWAIN only. With this option, Delivery Server, e-mail, Send File (SMB), and Send File (FTP) are not available.

- The following table shows which standby screen will be displayed as the Send Scan initial screen in accordance with the settings in **[1.Select Method]** and **[7.Select Method]** (which settings are included in **[2.Send Scan Settings]**).

		1.Select Method	
		Send	TWAIN
7.Select Method	Delivery Server/ TWAIN	Delivery Server standby screen	Network TWAIN standby screen
	Send File/ TWAIN	E-mail/ Send File standby screen	Network TWAIN standby screen
	TWAIN	-	Network TWAIN exclu- sive standby screen

Standby screens

- **Select Method screen**
While this screen is displayed, pressing the **[1]** key displays Delivery Server standby screen, E-mail/Send File standby screen, Network TWAIN standby screen, or Network TWAIN exclusive standby screen. Pressing the **[2]** key displays the Print Scan standby screen.
When you start the network TWAIN driver from a TWAIN-compliant application on a client computer, Network TWAIN standby screen is displayed. Press **[Exit]** to return to the Select Method screen.

Select number with the Number keys.	
1. Send Scan	2. Print Scan
OK	

- Delivery Server standby screen
While this screen is displayed, pressing **[Dest.]** enables you to deliver scan data using the address book in ScanRouter V2 Professional/Lite. You can also configure various settings using the control panel of this machine, or using a Web browser on a client computer. You can send any file by using a Web browser on a client computer; however, you cannot send an e-mail or send a file by SMB/FTP by using the control panel of this machine.

When you start the network TWAIN driver from a TWAIN-compliant application on a client computer, Network TWAIN standby screen is displayed. Press **[Exit]** to return to the Delivery Server standby screen.

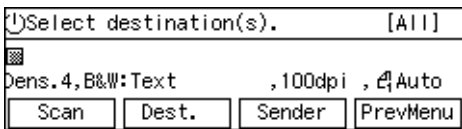

- E-mail/Send File standby screen
While this screen is displayed, pressing **[Dest.]** enables you to send an e-mail or send a file by SMB/FTP. You can also send any file by using a Web browser on a client computer, and configure various settings using the control panel of this machine or a Web browser on a client computer. You cannot deliver scan data by using Delivery Server. If you want to print scan data, press **[PrevMenu]** and display the Select Method screen.

When you start the network TWAIN driver from a TWAIN-compliant application on a client computer, Network TWAIN standby screen is displayed. Press **[Exit]** to return to the E-mail/Send File standby screen.

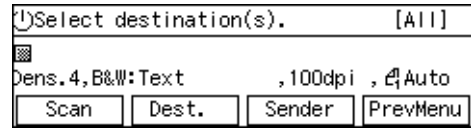

- Network TWAIN standby screen
While this screen is displayed, you can use this machine as a TWAIN scanner, by starting the network TWAIN driver from a TWAIN-compliant application on a client computer. You can also configure various settings using the control panel of this machine, or using a Web browser on a client computer. When this screen is initially displayed after you turn the machine's power on, pressing **[Exit]** will display either of the following screens:
 - Delivery Server standby screen (when " Delivery Server/ TWAIN " is selected for **[7.Select Method]** option)
 - E-mail/Send File standby screen (when " Send File/TWAIN " is selected for **[7.Select Method]** option)

While Select Method screen, Delivery Server standby screen, E-mail/Send File standby screen, or Print Scan standby screen is displayed, starting the network TWAIN driver from a TWAIN-compliant application on a client computer will display the Network TWAIN standby screen. Press **[Exit]** to return to the previous screen.

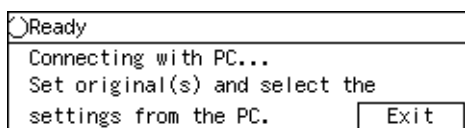

- Network TWAIN exclusive standby screen

While this screen is displayed, you can use this machine as a TWAIN scanner, by starting the network TWAIN driver from a TWAIN-compliant application on a client computer. You can also configure various settings using the control panel of this machine, or using a Web browser on a client computer. However, you cannot use the following functions: Print Scan, Delivery Server, e-mail, Send File (SMB), Send File (FTP), sending any file by using a Web browser on a client computer.

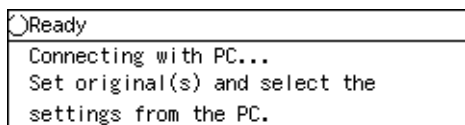

- Print Scan standby screen
- While this screen is displayed, you can print scan data.

If you want to use any other functions such as Delivery Server, e-mail or Send File (SMB/FTP), press **[PrevMenu]** and display the Select Method screen. At this time, functions you can use changes depending on the settings in **[1.Select Method]** and **[7.Select Method]**.

When you start the network TWAIN driver from a TWAIN-compliant application on a client computer, Network TWAIN standby screen is displayed. Press **[Exit]** to return to the Print Scan standby screen.

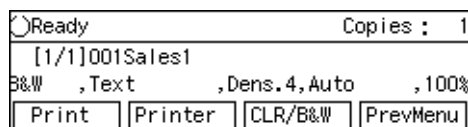

Scanner Features Menu

Pressing the **[User Tools]** key displays the Scanner Features menu. You can configure settings for network, Send Scan, Print Scan, and Scan/Print conditions to meet your requirements.

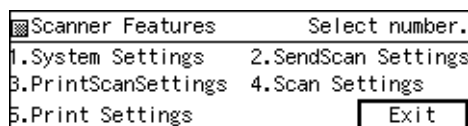

2. Setting Up the Scanner

This section explains how to setup the scanner to get it ready for use, and how to make necessary connections.

Checking the Scanner Location

Before setting up the scanner, take a few minutes to check the location where you are going to install the scanner.

⚠ **WARNING:**

- Make sure the wall outlet is near the machine and easily accessible so that in event of an emergency it can be unplugged easily.

⚠ **CAUTION:**

- Keep the machine away from humidity and dust. A fire or an electric shock might occur.
- Do not place the machine on an unstable or tilted surface. If it topples over, it could cause injury.

- Place the scanner on a level, stable, vibrating-free surface. Allowable inclination of the surface for installation is within 5mm (0.2") (when measuring difference of heights between an end and the other end of this machine, compared to a level surface).

❖ **Installation space**

Make sure that the scanner is in a location where there is enough space to provide the clearance as illustrated below, and also provide a comfortable working area in the front.

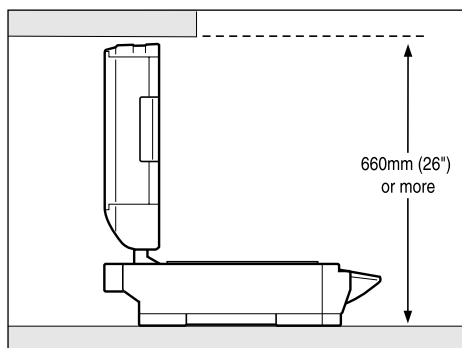
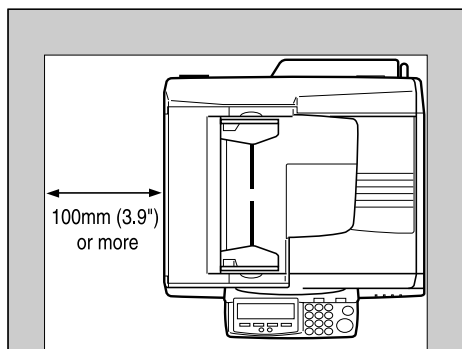

❖ Installation environment

⚠ Important

- ❑ Do not set up the scanner in any of the following types of locations. Doing so creates the risk of malfunction of the scanner.
 - In a location exposed to direct sunlight
 - In a location where the scanner will be subjected to blowing air or radiant heat, such as near an air conditioner or heater
 - In a location near other electronic devices, such as a radio or television set
 - In a location subject to extreme temperatures or humidity
 - Near a humidifier

Set up the scanner in a location where the temperature and humidity will fall within the ranges shown below.

⚠ Important

- ❑ Save the box and cushioning material in which the scanner was packed so that they can be used if it is necessary to transport the scanner in the future.
- ❑ When the machine is moved from a cold location to a warm location, sudden temperature changes cause condensation inside of the scanner. Wait one hour or more before turning on the scanner to allow the condensation to evaporate.

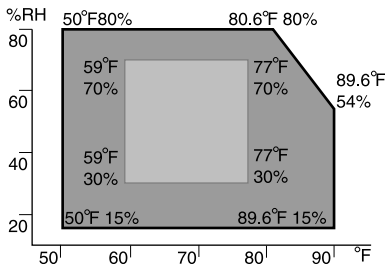
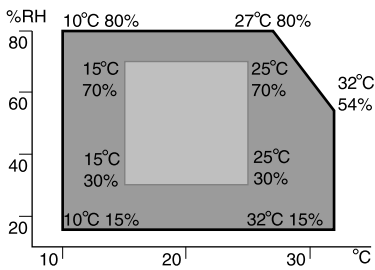

Possible operation range
 Recommended range

The machine must be level within 5 mm, 0.2" both front to rear and left to right.

Attaching the Control Panel Unit to the Scanner Unit

Note

- Use the tool that comes with this machine when you tighten or loosen the screws.

- 1** Insert the plug of the control panel unit into the socket on the scanner unit, as illustrated below.

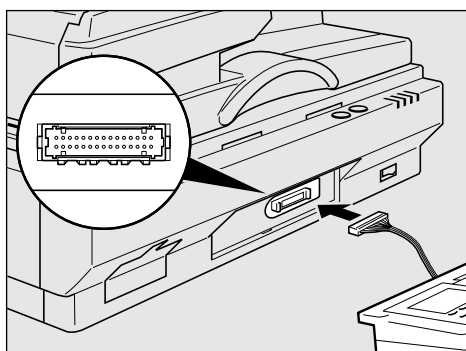

Important

- While making sure that the plug is facing in the correct direction, inset the plug as far as it goes into the socket. It may be a bit tight to insert the plug into the socket, so push the plug with a strength that is enough for inserting it in place.

Note

- To avoid the plug being inserted in the wrong direction, the socket has a number of tiny prongs inside of it. When you insert the plug into the socket, make sure that the socket is facing in the correct direction. Inserting in the wrong direction creates the risk of damage to the plug and the socket.
- Be careful not to pinch the cable when you attach the control panel unit to the scanner unit.

- Locating the scanner unit at an end of a desk makes it easy to attach the control panel unit.

- 2** Insert the hooks of the control panel unit to the scanner unit.

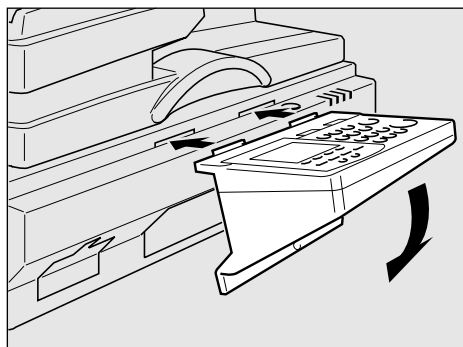

- 3** Secure the control panel unit using the screw that comes with this machine.

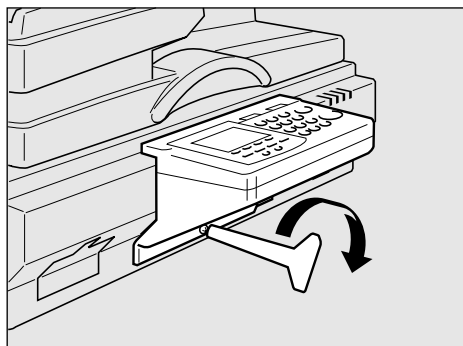

Note

- Do not open the cover located at the lower left of the control panel. Changing configuration of the switches inside of the cover could cause this machine to stop operating normally.

Connecting to a Local Printer

You can make a USB connection between this machine and a printer, when you want to use it as a local printer for Print Scan. This section explains how to connect a printer to this machine using a USB cable.

2

 **Note**

- When you connect a local printer to this machine, be sure to use the USB cable that comes with this machine.
- See the manuals that come with the printer you are going to connect to this machine, for details about the printer's connections and setup information.

1 Turn off the power of this machine.

2 Insert the USB interface card that comes with this machine to the PC Card slot on the rear panel of this machine.

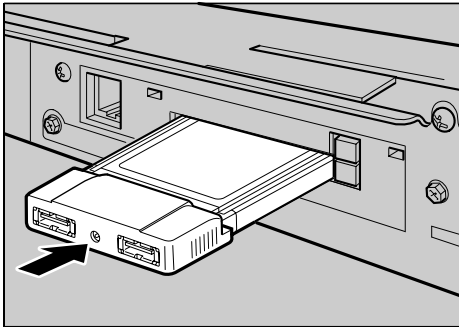

ADG006S

 **Note**

- Make sure that the card is securely inserted, until you feel the card click into place.

 **Important**

- If you remove the USB interface card while the machine's power is on, it is necessary to restart the machine.

3 Connect a USB cable to one of the USB ports of the USB interface card.

4 Connect the other end of the USB cable to the USB port of the printer.

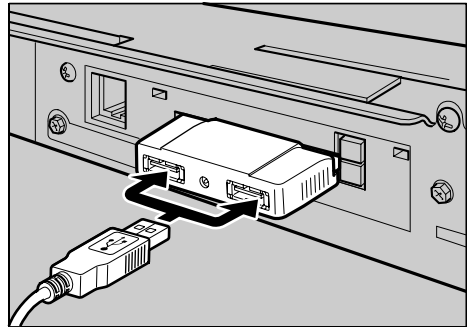

ADG007S

 **Important**

- You cannot use more than one printer as a local printer for Print Scan at the same time. When you connect two or more printers to the machine using USB cables, the printer that is detected by this machine first is only available.

- 5** Attach the card slot cover that comes with this machine.

To attach the card slot cover

- 1** Reeve the USB cable through one of the slits of the card slot cover.

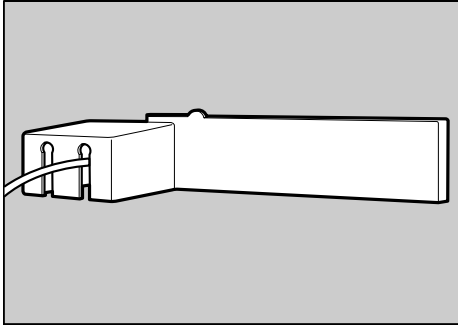

ADG008S

Note

- When you connect two printers to this machine, reeve one of the USB cables through a slit, and the other USB cable through the other slit.
 - This step is not necessary when you use an optional wireless LAN card instead of the USB interface card.
- 2** Align the two prongs of the card slot cover with the two prong holes located at the upper left and right of the PC card slot.

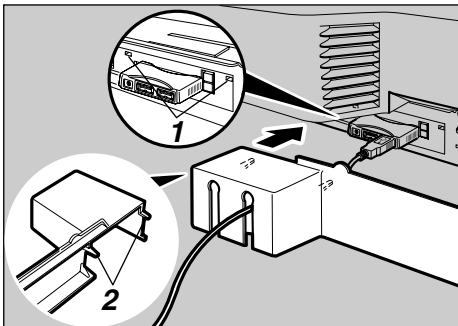

ADG009S

- 1.** Prong holes

- 2.** Prongs

- 3** Insert the prongs to the prong holes, and then push both sides of the card slot cover until it is secured to the rear panel of this machine.

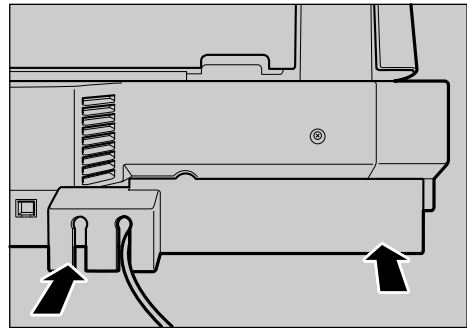

ADG010S

Setting Up the Optional Accessories

2

Installing the Image Processing Unit

⚠ Important

- ❑ Before touching the Image Processing Unit, be sure to touch any metal object in order to discharge static electricity from your body.

🔧 Note

- ❑ Use the tool that comes with this machine when you tighten or loosen the screws.

1 Turn off the power of this machine, and unplug all the cables connected to this machine including the power cord.

2 Remove the four screws at the bottom of the rear panel of this machine.

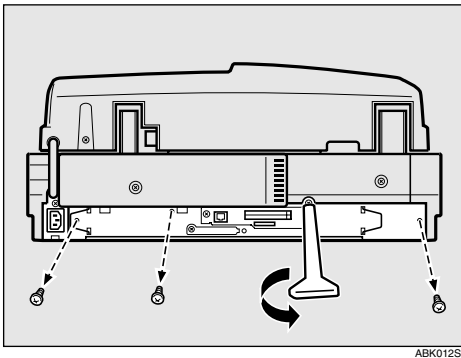

3 Pull out the scanner control unit.

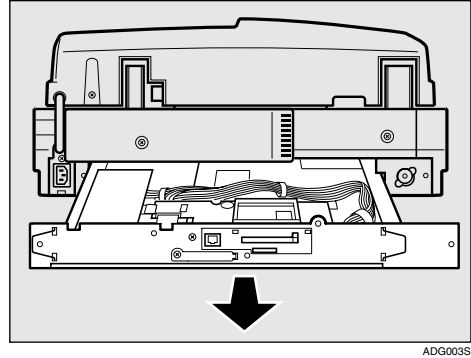

⚠ Important

- ❑ The scanner control unit is very heavy. Be careful not to drop it when removing.

4 Insert the connector located on the back of the Image Processing Unit to the socket on the scanner control unit, and then secure the Image Processing Unit using the screw that comes with it.

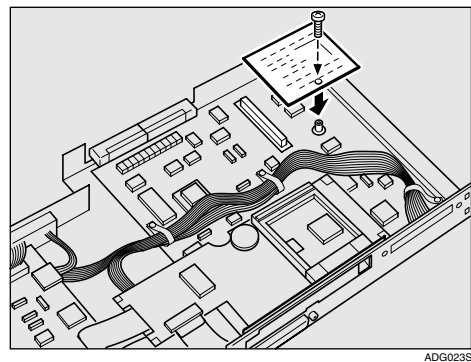

5 Confirm that the Image Processing Unit is securely fastened, and make sure that there is no foreign objects on the scanner control unit.

6 Replace the scanner control unit into the scanner unit, and then secure it with the four screws.

- 7** Connect the cables that you have unplugged in step **1**. Be sure to connect the power cord last of all.

Inserting a Wireless LAN Card

Note

- You cannot use the optional wireless LAN card and the bundled USB interface card at the same time.

- 1** Turn off the power of this machine.

- 2** Insert the wireless LAN card to the PC Card slot on the rear panel of this machine.

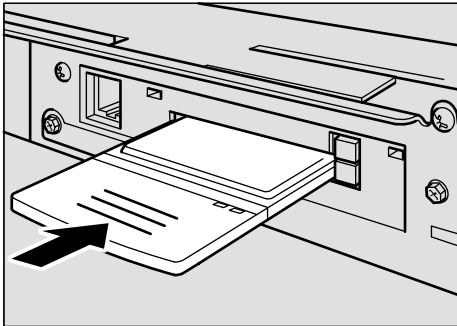

ADG005S

Note

- Only a single side of the wireless LAN card has three horizontal lines, which is located on the black end of the card. When you insert the card, make sure that the side with the three lines is facing up. Inserting in the wrong direction creates the risk of damage to the card and the card slot.
- Make sure that the card is securely inserted, until you feel the card click into place.

- 3** Attach the card slot cover that comes with this machine.

Reference

See p.27 “To attach the card slot cover” for information about how to attach the card slot cover.

Connecting to a Network

This section explains how to connect this machine to a network.

Important

- ❑ Use a 100BASE-TX (category 5) or 10BASE-T network cable when you connect this machine to a network.

1 With the network cable you use for connection, create a single loop about 15cm (6") (①) away from an end of the cable, and then attach the ferrite core that comes with this machine as illustrated below.

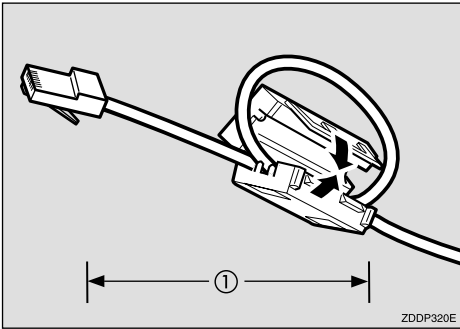

Note

- ❑ Skip this step when you use this machine in North America.

2 Insert the network cable's end that has the ferrite core into the network interface connector of this machine.

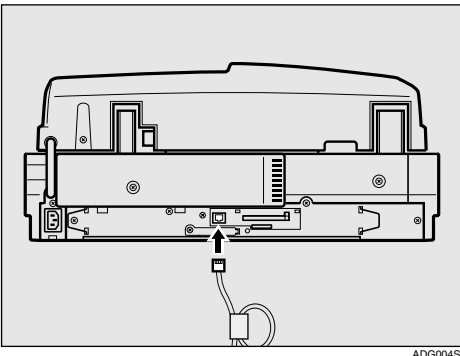

Note

- ❑ When you use this machine in North America, insert an end of the network cable into the network interface connector of this machine.

3 Insert the other end of the network cable into an appropriate connector of a network device, such as an Ethernet hub.

Connecting to a Power Source

This section explains how to connect this machine to a power source, using the bundled AC power cord.

⚠ WARNING:

- Do not use with a power source with a voltage different from the specified voltage. Do not use a power outlet with multiple devices plugged in. These could create the risk of fire or electric shock.
- Avoid the use of an extension cord.
- Do not damage, break, twist or modify the Power Cord. Placing heavy objects on the cord, pulling on or bending it excessively can damage the Power Cord, creating the risk of fire or electric shock.
- Never touch or unplug the power plug with wet hands. This can create the risk of electric shock.

⚠ CAUTION:

- When unplugging from an outlet, be sure to grasp the plug when pulling. Never pull on the cord. This could damage the cord creating the risk of fire or electrical shock.

1 Confirm that the power switch is set to off.

2 Confirm that the lock switch located on the left side of the machine is set to the “Unlock” position.

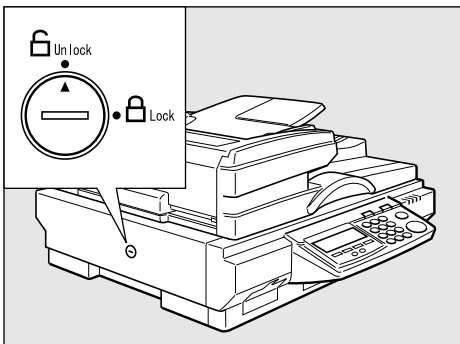

ZDLH350

⚠ Important

- ❑ Be sure to set the lock switch to “Unlock”. Turning on the power with the lock switch set to “Lock” could result in failure in scanning or malfunction of this machine.

3 Push the power cord plug all the way into the power connector on this machine.

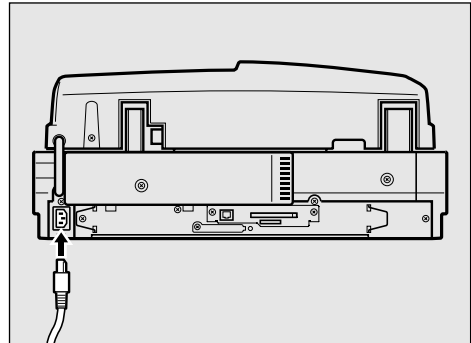

ADG024S

📌 Note

- ❑ Be sure to use the power cord that comes with this machine.

4 Insert the power plug into the power outlet.



.....

 **Before turning off the power**

Before you turn off the power of this machine, make sure that a standby screen is displayed on the display panel.

2

If you turn off the power while the Scanner Features menu is displayed, all the settings that you have configured could be discarded, and this machine could return to its factory default status.

You should also confirm that  is not displayed on the screen, or the  indicator on the front of this machine is not lit, when you turn off the power. Otherwise, loss of scan data or failure in sending files might occur.

.....

3. Configuring the Scanner Settings

Outline to Use As a Network Twain Scanner

The following overview diagram shows the preparation steps for using this machine as a network TWAIN scanner. Note that the underlined steps are essential.

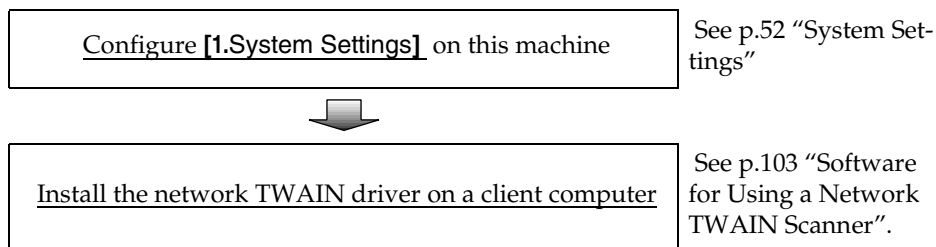

*1 If you use this machine as a network TWAIN scanner, you need a TWAIN-compliant application on the client computer you use. DeskTopBinder V2 Lite that comes with this machine is a TWAIN-compliant application.

Outline to Use Scan to E-mail

The following overview diagram shows the preparation steps for sending scan files as e-mail attachments. Note that the underlined steps are essential.

Reference

There are three types of setup items: 1) items that you can configure settings using the control panel of this machine, 2) items that you can configure settings using a Web browser on a client computer, 3) items that you can configure settings using both of the above. See p.41 “Initial Scanner Setup” for details. This manual covers only the setting procedures that you can perform using the control panel of this machine. For details about settings this manual does not cover, see the Web Status Monitor Help. For information about how to view the Web Status Monitor, see p.84 “Accessing the Scanner”

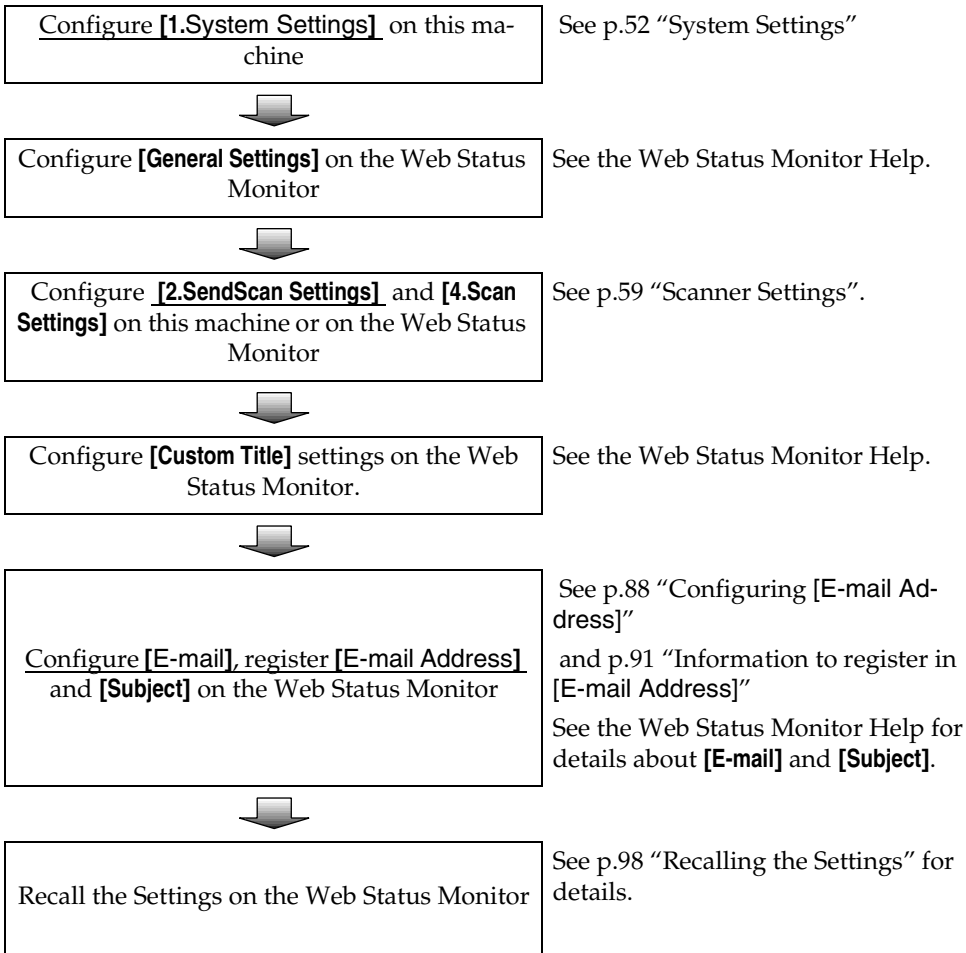

Outline to Use Scan to Folder

The following overview diagram shows the preparation steps for sending scan files to shared folders of Windows using SMB protocol. Note that the underlined steps are essential.

Reference

There are three types of setup items: 1) items that you can configure settings using the control panel of this machine, 2) items that you can configure settings using a Web browser on a client computer, 3) items that you can configure settings using both of the above. See p.41 “Initial Scanner Setup” for details.

This manual covers only the setting procedures that you can perform using the control panel of this machine. For details about settings this manual does not cover, see the Web Status Monitor Help. For information about how to view the Web Status Monitor, see p.84 “Accessing the Scanner”.

3

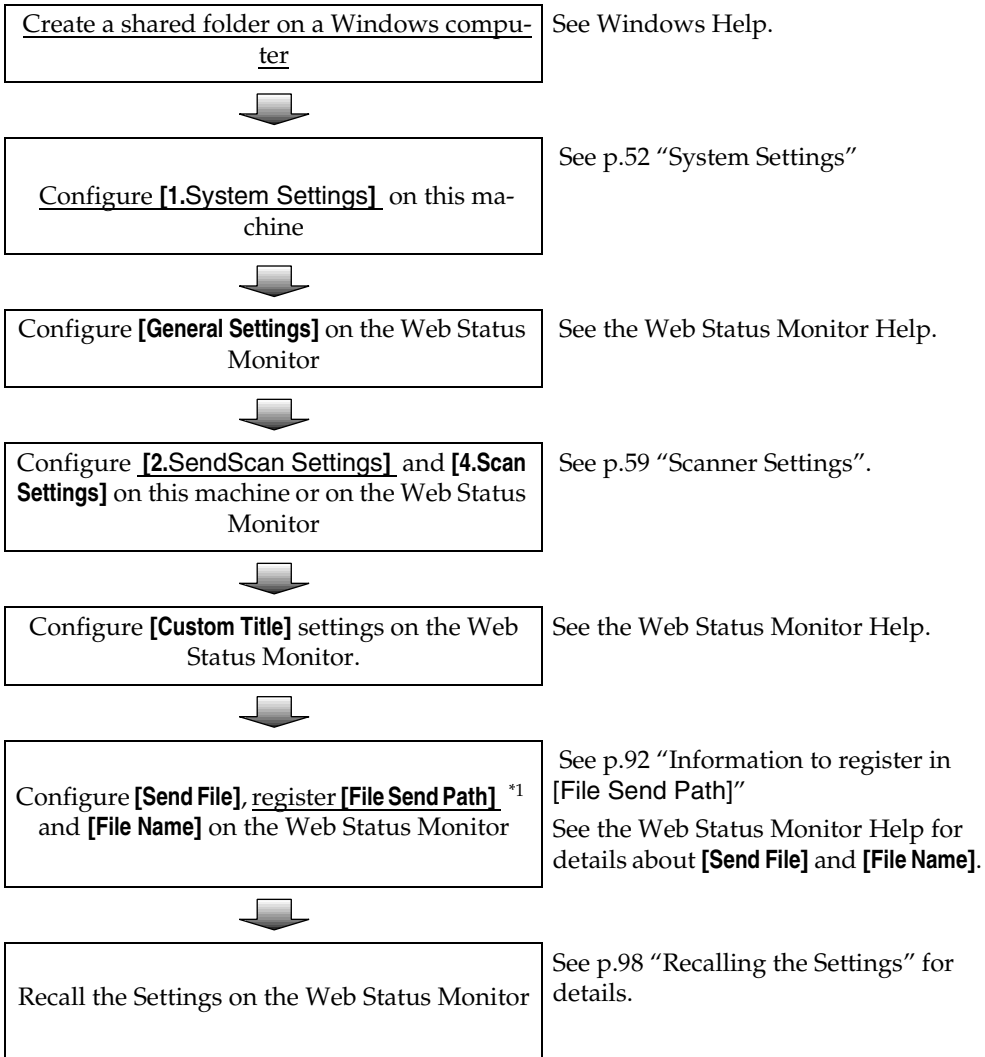

*1 This setting becomes essential if you want to perform Scan to Folder (SMB) operation from this machine. When you perform [Enter Custom Send File] operation using the Web Status Monitor, it is not necessary to register [File Send Path] in advance.

Outline to Use Scan to FTP

The following overview diagram shows the preparation steps for sending scan files to folders on an FTP server. Note that the underlined steps are essential.

Reference

There are three types of setup items: 1) items that you can configure settings using the control panel of this machine, 2) items that you can configure settings using a Web browser on a client computer, 3) items that you can configure settings using both of the above. See p.41 “Initial Scanner Setup” for details.

This manual covers only the setting procedures that you can perform using the control panel of this machine. For details about settings this manual does not cover, see the Web Status Monitor Help. For information about how to view the Web Status Monitor, See p.84 “Accessing the Scanner”

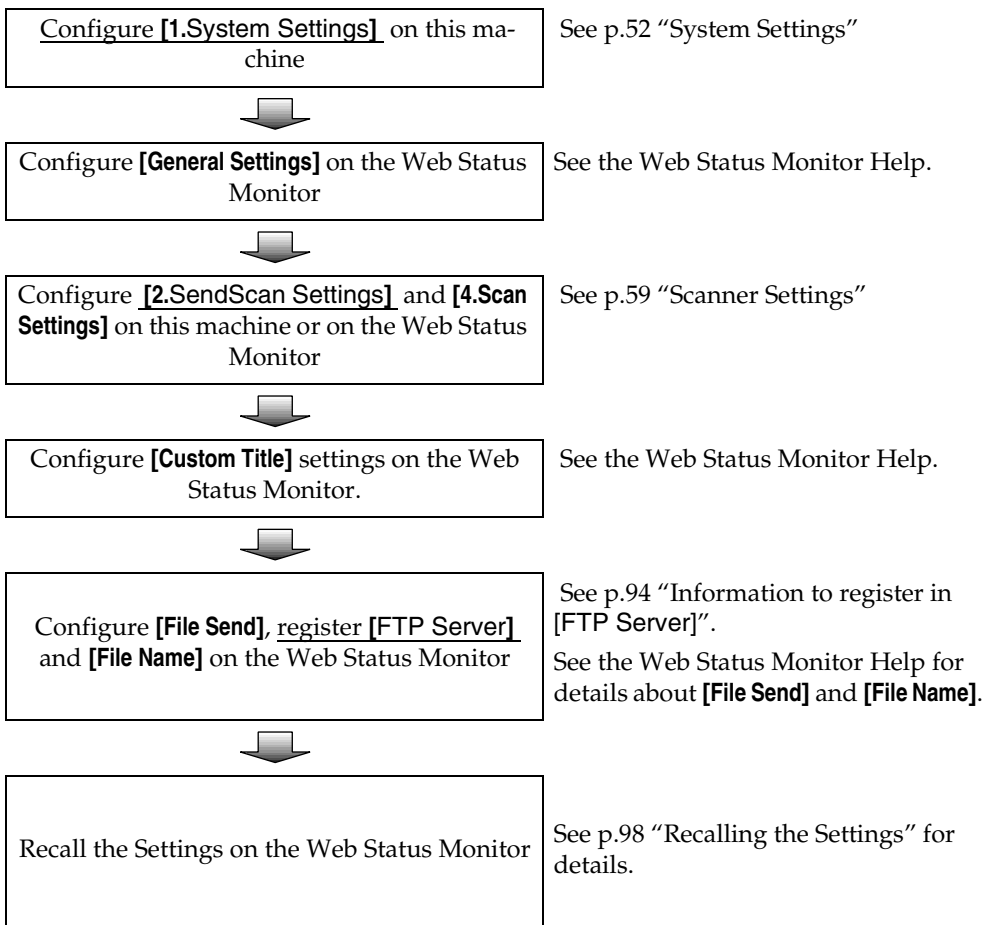

Outline to Use the Network Delivery

The following overview diagram shows the preparation steps to use this machine as a network delivery scanner, which function is enabled using ScanRouter V2 Professional/Lite. Note that the underlined steps are essential.

Reference

There are three types of setup items: 1) items that you can configure settings using the control panel of this machine, 2) items that you can configure settings using a Web browser on a client computer, 3) items that you can configure settings using both of the above. See p.41 “Initial Scanner Setup” for details.

This manual covers only the setting procedures that you can perform using the control panel of this machine. For details about settings this manual does not cover, see the Web Status Monitor Help. For information about how to view the Web Status Monitor, see p.84 “Accessing the Scanner”

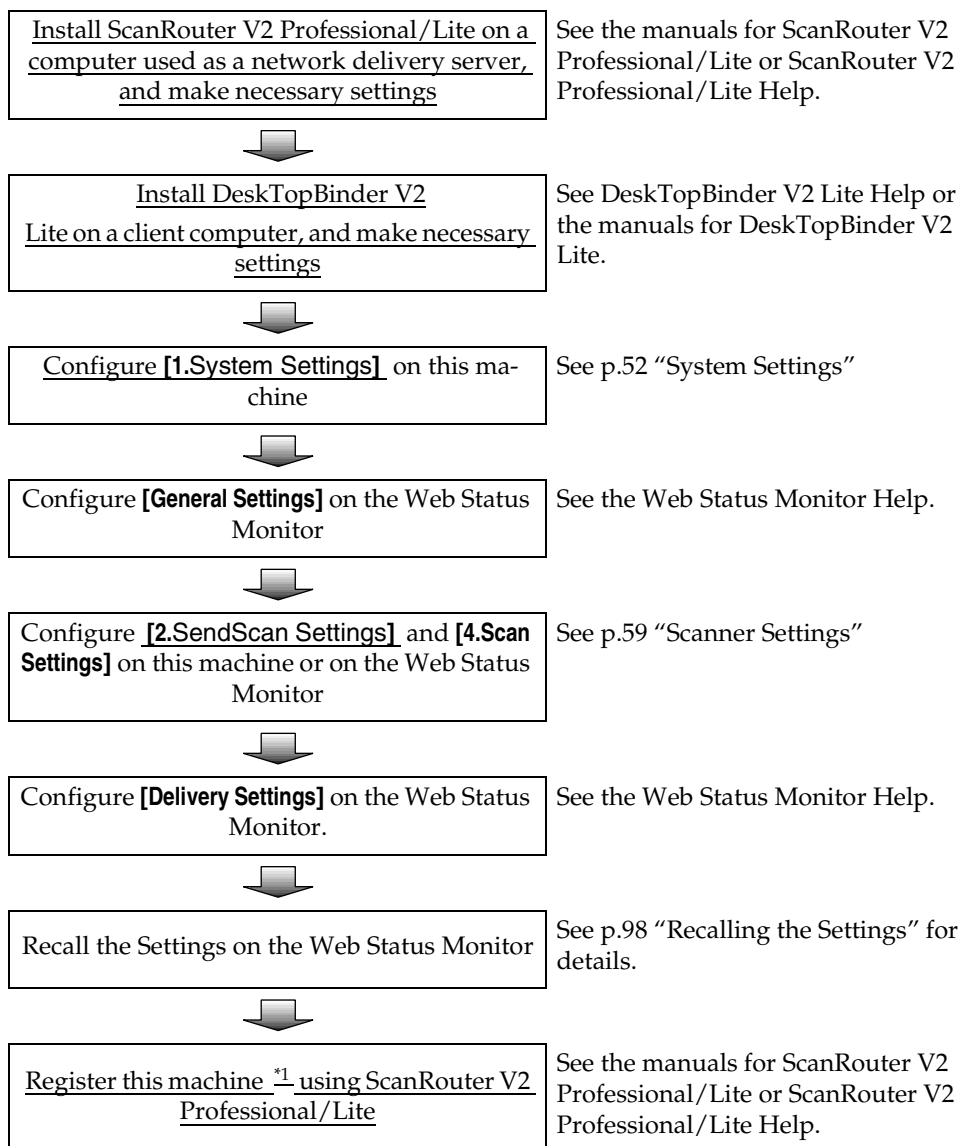

*1 Enter the IP address directly using **[Set I/O Device]**.

Outline to Use Scan to Print

The following overview diagram shows the preparation steps for printing scan data by Print Scan. Note that the underlined steps are essential.

Reference

There are three types of setup items: 1) items that you can configure settings using the control panel of this machine, 2) items that you can configure settings using a Web browser on a client computer, 3) items that you can configure settings using both of the above. See p.41 “Initial Scanner Setup” for details.

This manual covers only the setting procedures that you can perform using the control panel of this machine. For details about settings this manual does not cover, see the Web Status Monitor Help. For information about how to view the Web Status Monitor, see p.84 “Accessing the Scanner”

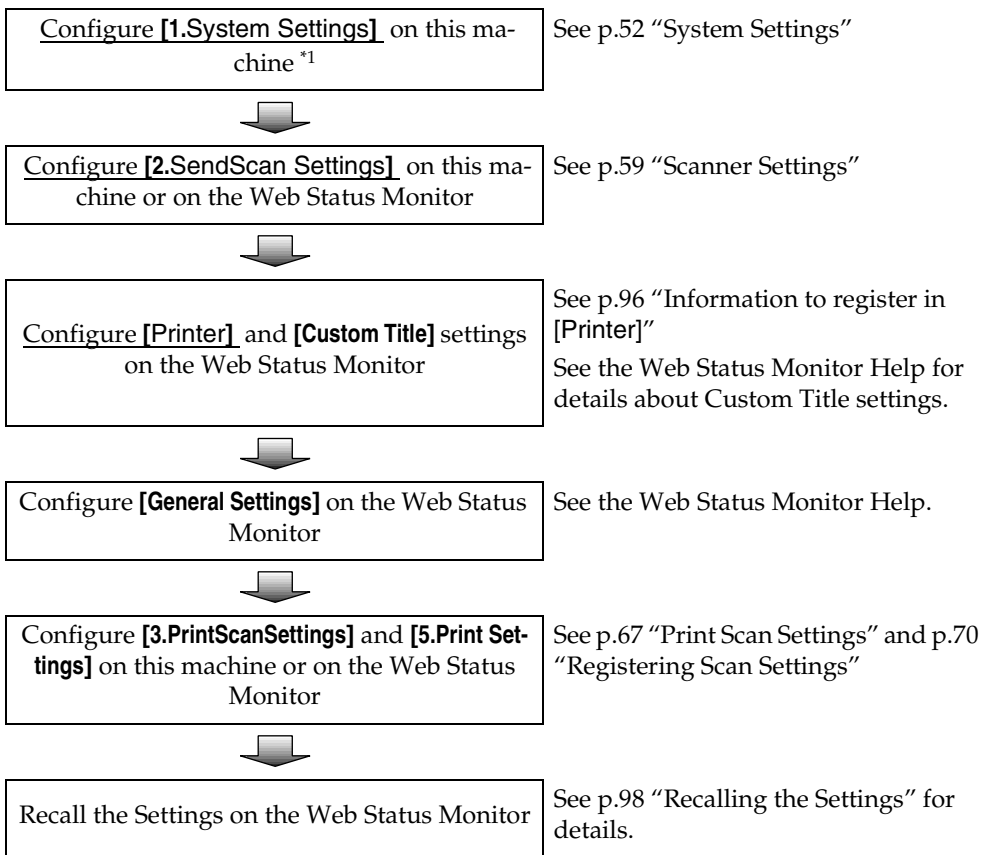

*1 This step is essential only when you use a network printer. This step is not essential when you use a local printer.

Initial Scanner Setup

The table on the next page shows all the setup items and their factory default values. The table also includes information about for which of the functions each of the setup items is used (see the columns under "Purpose"), and the available method for configuration (see the columns under "Method").

For information about how to configure each of the setup items and how it works, see the sections from p.52 "System Settings" to p.84 "Configuring Settings Using a Web Browser", and also see the Web Status Monitor Help.

Important

- Under "Purpose" in the table on the next page, there is a column for each of the functions listed below.

Column name:	Means the function for:
Delivery Server	Sending scan files by a delivery server using ScanRouter V2 Professional/Lite.
Mail	Sending scan files as e-mail attachments.
SMB	Sending scan files to a Windows shared folder.
FTP	Sending scan files to an FTP server.
Print	Printing scan files.
TWAIN	Using this machine as a network TWAIN scanner.

- A "☉" in a column means that the setup item to the left is essential to use the function. Be sure to configure these settings before using this machine.
- A "○" in a column means that the setup item to the left is related to the function, but is not essential. Configure these settings as necessary.
- No mark in a column means that the setup item to the left has no direct relation to the function.

- Under "Method" in the table on the next page, there is a column for each of the setup method listed below.

Column name:	Means if:
Scanner	Each of the setup items to the left can be configured using the control panel of this machine.
Web	Each of the setup items to the left can be configured using the Web Status Monitor.

- A "○" in a column means that the setup item to the left can be configured using the method.
- A "x" in a column means that the setup item to the left cannot be configured using the method. Use the other available method for the setting.
- A "-" in a column means that the item to the left cannot be changed (for the display information purpose only).

□ A "(null)" in the "Factory default value" column means that the setup item to the left has no factory default value.

Setup Item		Factory Default Value	Purpose					Method		
			Delivery Server	Mail	SMB	FTP	Print	TW AIN	Scanner	Web
Basic Settings										
General Settings	Device Name	RNP***** *1		○	○	○		○	×	○
	Comment	(null)							×	○
	URL Name	URL							×	○
	URL	/cgi-bin /url.cgi/							×	○
	Help URL	/cgi-bin /help.cgi							×	○
System Settings or TCP/IP *2	Function Priority	Select: Send/Print	○	○	○	○	○	○	○	×
	LAN Type	Ethernet	○	○	○	○	○	○	○	○
	IP Address	11.22.33.44	⊙ *3	⊙ *3	⊙ *3	⊙ *3	⊙ *3 *4	⊙ *3	○	○ *5
	Subnet Mask	0.0.0.0	⊙ *3	⊙ *3	⊙ *3	⊙ *3	⊙ *3 *4	⊙ *3	○	○
	Default Gateway Address	0.0.0.0	⊙ *3	⊙ *3	⊙ *3	⊙ *3	⊙ *3 *4	⊙ *3	○	○
	Access Control	0.0.0.0						○	○	○
	Access Mask	0.0.0.0						○	○	○
	DNS Server 1 IP Address	(null)		⊙					×	○
	DNS Server 2 IP Address	(null)		○					×	○
	DNS Server 3 IP Address	(null)		○					×	○
	Delivery Server IP Address	0.0.0.0	⊙ *6						—	— *7
	MAC Address	(Unique to each unit)							—	— *8
Network Boot	NONE	○	○	○	○	○ *4	○	○	○	

Setup Item		Factory Default Value	Purpose					Method		
			Delivery Server	Mail	SMB	FTP	Print	TW AIN	Scanner	Web
System Settings or TCP/IP *2	Transmission Speed	Auto	<input type="radio"/>	<input type="radio"/>	<input type="radio"/>	<input type="radio"/>	<input type="radio"/> *4	<input type="radio"/>	<input type="radio"/>	<input type="radio"/>
	Communication Mode *9	802.11 Ad hoc mode	<input type="radio"/>	<input type="radio"/>	<input type="radio"/>	<input type="radio"/>	<input type="radio"/> *4	<input type="radio"/>	<input type="checkbox"/>	<input type="radio"/>
	SSID *9, *10	ASSID	<input type="radio"/>	<input type="radio"/>	<input type="radio"/>	<input type="radio"/>	<input type="radio"/> *4	<input type="radio"/>	<input type="checkbox"/>	<input type="radio"/>
	Channel *9, *11	11	<input type="radio"/>	<input type="radio"/>	<input type="radio"/>	<input type="radio"/>	<input type="radio"/> *4	<input type="radio"/>	<input type="checkbox"/>	<input type="radio"/>
	WEP Setting *9	Disable	<input type="radio"/>	<input type="radio"/>	<input type="radio"/>	<input type="radio"/>	<input type="radio"/> *4	<input type="radio"/>	<input type="checkbox"/>	<input type="radio"/>
	WEP Key *9, *12	(null)	<input type="radio"/>	<input type="radio"/>	<input type="radio"/>	<input type="radio"/>	<input type="radio"/> *4	<input type="radio"/>	<input type="checkbox"/>	<input type="radio"/>
	Wireless LAN Signal	(Display only)							—	—
SNMP *13	Community Name	public *14	<input type="radio"/>					<input type="radio"/>	<input type="checkbox"/>	<input type="radio"/>
		admin *15								
		(null) *16								
	Access Type	read-only *14	<input type="radio"/>					<input type="radio"/>	<input type="checkbox"/>	<input type="radio"/>
		read-write *15								
		Not Accessible *16								
Protocol	TCP/IP	<input type="radio"/>					<input type="radio"/>	<input type="checkbox"/>	<input type="radio"/>	
Manager IP Address	0.0.0.0							<input type="checkbox"/>	—	
Password	Current Password	(null)							<input type="checkbox"/>	<input type="radio"/>
	New Password and Confirm Password	(null)							<input type="checkbox"/>	<input type="radio"/>
Scan Settings *17	Scan Type	Binary:Text	<input type="radio"/>	<input type="radio"/>	<input type="radio"/>	<input type="radio"/>			<input type="radio"/>	<input type="radio"/>
	Resolution	100dpi	<input type="radio"/>	<input type="radio"/>	<input type="radio"/>	<input type="radio"/>			<input type="radio"/>	<input type="radio"/>
	Scan Size	Auto Detect	<input type="radio"/>	<input type="radio"/>	<input type="radio"/>	<input type="radio"/>			<input type="radio"/>	<input type="radio"/>
	Image Density	4	<input type="radio"/>	<input type="radio"/>	<input type="radio"/>	<input type="radio"/>			<input type="radio"/>	<input type="radio"/>

Setup Item		Factory Default Value	Purpose					Method		
			Delivery Server	Mail	SMB	FTP	Print	TWAIN	Scanner	Web
Scan Settings *17	Noise Reduction	Off	<input type="radio"/>	<input type="radio"/>	<input type="radio"/>	<input type="radio"/>			<input type="radio"/>	<input type="radio"/>
	Edge Smoothing	Off	<input type="radio"/>	<input type="radio"/>	<input type="radio"/>	<input type="radio"/>			<input type="radio"/>	<input type="radio"/>
	Filter	None	<input type="radio"/>	<input type="radio"/>	<input type="radio"/>	<input type="radio"/>			<input type="radio"/>	<input type="radio"/>
	Inversion	Off	<input type="radio"/>	<input type="radio"/>	<input type="radio"/>	<input type="radio"/>			<input type="radio"/>	<input type="radio"/>
	Erase Colour	Green	<input type="radio"/>	<input type="radio"/>	<input type="radio"/>	<input type="radio"/>			<input type="radio"/>	<input type="radio"/>
	File Type	Single Page		<input type="radio"/>	<input type="radio"/>	<input type="radio"/>			<input type="radio"/>	<input type="radio"/>
	Original Settings	<input checked="" type="checkbox"/> : 1 Sided	<input type="radio"/>	<input type="radio"/>	<input type="radio"/>	<input type="radio"/>			<input type="radio"/>	<input type="checkbox"/>
Print Settings *17	Scan Type	Text					<input type="radio"/>		<input type="radio"/>	<input type="radio"/>
	Image Density	4					<input type="radio"/>		<input type="radio"/>	<input type="radio"/>
	Original Size	Auto Detect					<input type="radio"/>		<input type="radio"/>	<input type="radio"/>
	Duplex	1 Sided Orig. -> 1 Sided Print					<input type="radio"/>		<input type="radio"/>	<input type="radio"/>
	Reduce/Enlarge, Zoom	100%					<input type="radio"/>		<input type="radio"/>	<input type="radio"/>
	Create Margin	Off					<input type="radio"/>		<input type="radio"/>	<input type="checkbox"/>
	Quality/Speed	Speed					<input type="radio"/>		<input type="radio"/>	<input type="checkbox"/>
Scanner	Function Priority (Web Status Monitor), Select Method (Scanner)	Send File	<input type="radio"/>	<input type="radio"/>	<input type="radio"/>	<input type="radio"/>	<input type="radio"/>	<input type="radio"/>	<input type="radio"/>	<input type="radio"/>
	TWAIN Standby Time	Off	<input type="radio"/>	<input type="radio"/>	<input type="radio"/>	<input type="radio"/>	<input type="radio"/>	<input type="radio"/>	<input type="radio"/>	<input type="radio"/>
	Auto Reset Timer	Off	<input type="radio"/>	<input type="radio"/>	<input type="radio"/>	<input type="radio"/>	<input type="radio"/>		<input type="radio"/>	<input type="radio"/>
	Date/Time	(Current time)	<input type="radio"/>	<input type="radio"/>	<input type="radio"/>	<input type="radio"/>	<input type="radio"/>		<input type="radio"/>	<input type="radio"/>
	Compression (Black and White)	On	<input type="radio"/>	<input type="radio"/>	<input type="radio"/>	<input type="radio"/>			<input type="radio"/>	<input type="radio"/>

Setup Item		Factory Default Value	Purpose						Method	
			Delivery Server	Mail	SMB	FTP	Print	TWAIN	Scanner	Web
Scanner	Compression (Gray Scale/Full Colour)	Normal Compression	<input type="radio"/>	<input type="radio"/>	<input type="radio"/>	<input type="radio"/>			<input type="radio"/>	<input type="radio"/>
	Function Options (Web Status Monitor), Select Method (Scanner)	Send File/TWAIN	<input type="radio"/>	<input type="radio"/>	<input type="radio"/>	<input type="radio"/>	<input type="radio"/>	<input type="radio"/>	<input type="radio"/>	<input type="radio"/>
	Auto Update Destination List	Off	<input type="radio"/>	<input type="radio"/>	<input type="radio"/>	<input type="radio"/>	<input type="radio"/>		<input type="radio"/>	<input type="radio"/>
	Unit of Measure	mm	<input type="radio"/>	<input type="radio"/>	<input type="radio"/>	<input type="radio"/>	<input type="radio"/>		<input type="radio"/>	<input type="radio"/>
	sRGB	Off	<input type="radio"/>	<input type="radio"/>	<input type="radio"/>	<input type="radio"/>			<input type="radio"/>	<input type="radio"/>
	End of Scan Option	Clear Settings after Each Scan Job	<input type="radio"/>	<input type="radio"/>	<input type="radio"/>	<input type="radio"/>			<input type="radio"/>	<input type="radio"/>
	Border Erase	0mm	<input type="radio"/>	<input type="radio"/>	<input type="radio"/>	<input type="radio"/>			<input type="radio"/>	<input type="radio"/>
	Language Select	English	<input type="radio"/>	<input type="radio"/>	<input type="radio"/>	<input type="radio"/>	<input type="radio"/>	<input type="radio"/>	<input type="radio"/>	<input type="radio"/>
	ADF Thin Paper	Off	<input type="radio"/>	<input type="radio"/>	<input type="radio"/>	<input type="radio"/>			<input type="radio"/>	<input type="radio"/>
	Job Delivery Data Max. Setting	On (1MB)	<input type="radio"/>							× ^{*7}
	Wait Time for Additional Scanning	3 second(s)	<input type="radio"/>	<input type="radio"/>	<input type="radio"/>	<input type="radio"/>			×	<input type="radio"/>
	Select Title	Alphabets		<input type="radio"/>	<input type="radio"/>	<input type="radio"/>	<input type="radio"/>		×	<input type="radio"/>
	Time Zone	GMT		<input type="radio"/>					×	<input type="radio"/>
	Scanned Sheet Counter	(Display only)							—	×
	Scanned Page Counter	(Display only)							—	×
ADF Pad Counter	(Display only)							—	×	

Setup Item		Factory Default Value	Purpose						Method	
			Delivery Server	Mail	SMB	FTP	Print	TWAIN	Scanner	Web
Scanner	ADF Pick Roller Counter	(Display only)							—	×
	Firmware Version	(Display only)							—	× ^{*18}
Custom Title	Custom Title 1:	1		○	○	○	○		×	○
	Custom Title 2:	2		○	○	○	○		×	○
	Custom Title 3:	3		○	○	○	○		×	○
	Custom Title 4:	4		○	○	○	○		×	○
	Custom Title 5:	5		○	○	○	○		×	○
File Send Settings										
File Send	Interval Time for Resending	Off			○	○			×	○
	No. of Times to Resend	Off			○	○			×	○
	Job Delivery Data Max. Setting	Off			○	○			×	○
	File Name + Time	On			○	○			×	○
	Create Device Name Folder	On			○	○			×	○
File Send Path ^{*19}	Program No.	(Automatically assigned)			○				×	○
	File Send Path Name	(null)			○				×	○
	Key Display	(null)			○				×	○
	Assign Title : Alphabet	ABC			○				×	○
	Assign Title : Custom Title	1			○				×	○

Setup Item		Factory Default Value	Purpose					Method		
			Delivery Server	Mail	SMB	FTP	Print	TWAIN	Scanner	Web
File Send Path *19	Assign Title : Frequently Used Title(s)	On			<input type="radio"/>				×	<input type="radio"/>
	File Send Path	(null)			<input type="radio"/>				×	<input type="radio"/>
	Login User Name	(null)			<input type="radio"/>				×	<input type="radio"/>
	Login Password	(null)			<input type="radio"/>				×	<input type="radio"/>
	Protected Password	(null)			<input type="radio"/>				×	<input type="radio"/>
FTP Server *19	Program No.	(Automatically assigned)				<input type="radio"/>			×	<input type="radio"/>
	FTP Server Name	(null)				<input type="radio"/>			×	<input type="radio"/>
	Key Display	(null)				<input type="radio"/>			×	<input type="radio"/>
	Assign Title : Alphabet	ABC				<input type="radio"/>			×	<input type="radio"/>
	Assign Title : Custom Title	1				<input type="radio"/>			×	<input type="radio"/>
	Assign Title : Frequently Used Title(s)	On				<input type="radio"/>			×	<input type="radio"/>
	Server Name/Path Name	(null)				<input type="radio"/>			×	<input type="radio"/>
	Login User Name	(null)				<input type="radio"/>			×	<input type="radio"/>
	Login Password	(null)				<input type="radio"/>			×	<input type="radio"/>
	PASV Mode Configuration	Off				<input type="radio"/>			×	<input type="radio"/>
Protected Password	(null)				<input type="radio"/>			×	<input type="radio"/>	
File Name *20	File Name	(null)			<input type="radio"/>	<input type="radio"/>			×	<input type="radio"/>

Setup Item		Factory Default Value	Purpose					Method		
			Delivery Server	Mail	SMB	FTP	Print	TWAIN	Scanner	Web
E-mail Settings										
E-mail	POP Server Address	(null)		<input type="radio"/>					<input checked="" type="checkbox"/>	<input type="radio"/>
	POP Server Port No.	110		<input type="radio"/>					<input checked="" type="checkbox"/>	<input type="radio"/>
	SMTP Server Address	(null)		<input checked="" type="radio"/>					<input checked="" type="checkbox"/>	<input type="radio"/>
	SMTP Server Port No.	25		<input type="radio"/>					<input checked="" type="checkbox"/>	<input type="radio"/>
	Domain Name	(null)		<input checked="" type="radio"/>					<input checked="" type="checkbox"/>	<input type="radio"/>
	Authentication Method	Off		<input type="radio"/>					<input checked="" type="checkbox"/>	<input type="radio"/>
	Authentication User Name	(null)		<input checked="" type="radio"/>					<input checked="" type="checkbox"/>	<input type="radio"/>
	Authentication Password	(null)		<input checked="" type="radio"/>					<input checked="" type="checkbox"/>	<input type="radio"/>
	Sender's Name Default	Administrator's Address		<input type="radio"/>					<input checked="" type="checkbox"/>	<input type="radio"/>
	Administrator's Name	(null)		<input type="radio"/>					<input checked="" type="checkbox"/>	<input type="radio"/>
	Administrator's E-mail Address	(null)		<input type="radio"/>					<input checked="" type="checkbox"/>	<input type="radio"/>
	Interval Time for Resending E-mails	30		<input type="radio"/>					<input checked="" type="checkbox"/>	<input type="radio"/>
	No. of Times to Resend E-mails	1		<input type="radio"/>					<input checked="" type="checkbox"/>	<input type="radio"/>
Max. E-mail Size	Off		<input type="radio"/>					<input checked="" type="checkbox"/>	<input type="radio"/>	
E-mail Address ^{*21}	Program No.	(Automatically assigned)		<input type="radio"/>					<input checked="" type="checkbox"/>	<input type="radio"/>
	Name	(null)		<input type="radio"/>					<input checked="" type="checkbox"/>	<input type="radio"/>
	Key Display	(null)		<input type="radio"/>					<input checked="" type="checkbox"/>	<input type="radio"/>

Setup Item		Factory Default Value	Purpose					Method		
			Delivery Server	Mail	SMB	FTP	Print	TW AIN	Scanner	Web
E-mail Address *21	Assign Title : Alphabet	ABC		<input type="radio"/>					<input type="checkbox"/>	<input type="radio"/>
	Assign Title : Custom Title	1		<input type="radio"/>					<input type="checkbox"/>	<input type="radio"/>
	Assign Title : Frequently Used Title(s)	On		<input type="radio"/>					<input type="checkbox"/>	<input type="radio"/>
	E-mail Address	(null)		<input type="radio"/>					<input type="checkbox"/>	<input type="radio"/>
	Register as Sender	On		<input type="radio"/>					<input type="checkbox"/>	<input type="radio"/>
	Sender's Password	On		<input type="radio"/>					<input type="checkbox"/>	<input type="radio"/>
	Protected Password	(null)		<input type="radio"/>					<input type="checkbox"/>	<input type="radio"/>
Attach Subject	Subject	(null)		<input type="radio"/>					<input type="checkbox"/>	<input type="radio"/>
Delivery Settings										
Delivery	Delivery Server IP Address	0.0.0.0	<input checked="" type="radio"/> *6						— *22	—
	Interval Time for Redelivery	Off	<input type="radio"/>						<input type="checkbox"/>	<input type="radio"/>
	No. of Times to Redeliver	Off	<input type="radio"/>						<input type="checkbox"/>	<input type="radio"/>
	Job Delivery Data Max. Setting	On (1 MB)	<input type="radio"/>						<input type="radio"/> *23	<input type="radio"/>
Print Scan Settings										
Print Scan	Max. Number of Copies	999			<input type="radio"/>	<input type="radio"/>			<input type="checkbox"/>	<input type="radio"/>
	Color/Black and White	Black and White			<input type="radio"/>	<input type="radio"/>			<input type="checkbox"/>	<input type="radio"/>
Printer *24	Program No.	(Automatically assigned)		<input type="radio"/>					<input type="checkbox"/>	<input type="radio"/>
	Printer Name	(null)		<input type="radio"/>					<input type="checkbox"/>	<input type="radio"/>

Setup Item		Factory Default Value	Purpose					Method		
			Delivery Server	Mail	SMB	FTP	Print	TWAIN	Scanner	Web
Printer ^{*24}	Key Display	(null)		○					×	○
	Assign Title : Alphabet	ABC		○					×	○
	Assign Title : Custom Title	1		○					×	○
	Assign Title : Frequently Used Title(s)	On		○					×	○
	Attachment Type	Network Printer		○					×	○
	Printer IP Address	11.22.33.44		◎					×	○
	Default Printer	No ^{*25}		○					×	○
	Locked Print	Off		○					×	○
	Paper Source Tray	Auto		○					×	○

- *1 ***** is the last six digits of the machine's MAC address.
- *2 **[1.System Settings]** on this machine, and **[TCP/IP]** under **[Basic Settings]** on the Web Status Monitor.
- *3 An essential setting when **[Network Boot]** is set to " NONE ". Input nothing when **[Network Boot]** is set to " DHCP ".
- *4 When you use no network printers, you don't have to configure this setting.
- *5 Be sure to configure this setting on this machine first. You can change the setting on the Web Status Monitor after you configure the first time setting on the machine.
- *6 Automatically configured when you register this machine on ScanRouter V2 Professional/Lite. It is essential to register this machine on ScanRouter V2 Professional/Lite.
- *7 Display using **[Delivery]** under **[Delivery Settings]** on the Web Status Monitor.
- *8 Display using **[Network Interface Board]** under **[Admin Info.]** on the Web Status Monitor.
- *9 A setting when you use a wireless LAN card.
- *10 A setting when **[Communication Mode]** is set to " Infrastructure mode " or " 802.11 Ad hoc mode ".
- *11 A setting when **[Communication Mode]** is set to " Ad hoc mode " or " 802.11 Ad hoc mode ".
- *12 An essential setting when **[WEP Setting]** is set to " Enable ".
- *13 Available up to 10 registrations.
- *14 The default value applied to the Community Name 1.
- *15 The default value applied to the Community Name 2.
- *16 The default value applied to the Community Name 3 through 8.
- *17 Available up to 4 registrations, including " Default ".
- *18 Display using **[Status]** main menu on the Web Status Monitor.
- *19 Available up to 1000 registrations.
- *20 Available up to 30 registrations.
- *21 Available up to 2000 registrations.
- *22 Display using **[1.System Settings]** on this machine.
- *23 Display using **[2.SendScan Settings]** on this machine.

*²⁴ Available up to 99 registrations.

*²⁵ "Yes" is automatically selected for the first printer that is registered. "No" is selected for all other printers.

System Settings

This section describes the setup items contained in the System Settings menu. They include an item used to select the initial screen of the machine, and basic setup items for operating this machine on a network, such as an IP address setting. This section also shows you how to configure these settings using the control panel of this machine.

Note

- ❑ See p.186 "Using Wireless LAN" for information about how to use an optional wireless LAN card.

Information to Set in [System Settings]

Note

- ❑ You can configure the settings that are mentioned in this section, using the Web Status Monitor. However, you must configure the IP address setting using the control panel of this machine first. And then, you can change the setting on the Web Status Monitor.

❖ **Function Priority**

This item lets you select the initial screen that is displayed when you turn the power on.

- Select; Send/Print

Select number with the Number keys.	
1. Send Scan	2. Print Scan
OK	

When you select this option, " Select Method " screen is initially displayed. On this screen, pressing the **[1]** key displays the Delivery Server standby screen or the E-mail/Send File standby screen, depending on the settings in **[7.Select Method]**. Pressing the **[2]** key displays the Print Scan initial screen for printing scan data.

- Send Scan

Select destination(s).		[All]
Dens. 4, B&W: Text , 100dpi , Auto		
Scan	Dest.	Sender PrevMenu

When you select this option, the Delivery Server standby screen or the E-mail/Send File standby screen is initially displayed. The screen initially displayed depends on the settings in **[7.Select Method]**.

- Print Scan

Select Printer		Copies : 1
B&W , Text , Dens. 4, Auto , 100%		
Print	Printer	CLR/B&W PrevMenu

When you select this option, the Print Scan standby screen is displayed as the initial screen.

❖ **IP Address**

When a fixed IP address is assigned to this machine on the network you use, enter the IP address to this item in the form of xxx.xxx.xxx.xxx (xxx:0 through 255).

Do not specify this item manually when you use this machine on a DHCP environment. An IP address is automatically assigned to this machine by selecting " DHCP " for **[Network Boot]**.

❖ Subnet Mask

When a fixed IP address is assigned to this machine on the network you use, enter the subnet mask to this item in the form of xxx.xxx.xxx.xxx (xxx:0 through 255).

Do not specify this item manually when you use this machine on a DHCP environment, because this item is automatically assigned to this machine by selecting "DHCP" for **[Network Boot]**.

❖ Default Gateway Address

When a fixed IP address is assigned to this machine on the network you use, enter the default gateway address to this item in the form of xxx.xxx.xxx.xxx (xxx:0 through 255).

Do not specify this item manually when you use this machine on a DHCP environment, because this item is automatically assigned to this machine by selecting "DHCP" for **[Network Boot]**.

❖ Access Control and Access Mask

Use these setup items together to determine which of client computers has right to access this machine when it works as a network TWAIN scanner.

Each of the client computers is granted or denied its access to this machine by its IP address, which is determined by an access control entry and an access mask entry in combination. An access control entry is used as a reference value of the IP address, while an access mask entry determines the range of the IP addresses.

- Access control is the value that becomes the reference for restricting the client that uses this product as a network TWAIN scanner

- Access mask is the value to specify the restriction range. It is collated (logically multiplied) with access control to limit clients that can use this product as a network TWAIN scanner.

Specify both the access control and the access mask in the form of xxx.xxx.xxx.xxx (xxx:0 through 255).

Note

- When you want to set no limitation of access to this machine, leave these settings as their default values.
- When an IP address of a client computer falls within the logical products of the access control entry and the access mask entry, the client computer is granted its access to this machine.
- For example, a client computer that has an IP address within the range shown under "Access-enabled IP address" column in the following table has right to access this machine, in accordance with the entry of the access mask to the left, when you set the access control to 192.168.15.18. In the following table, "xxx" means any value is available.

Access mask entry	Access-enabled IP address
000.000.000.000	xxx.xxx.xxx.xxx
255.255.000.000	192.168.xxx.xxx
255.255.240.000	192.168.0.xxx ~192.168.15.xxx
255.255.255.000	192.168.15.xxx
255.255.255.240	192.168.15.16 ~192.168.15.31
255.255.255.255	192.168.15.18

❖ **Network Boot**

Use this item to select whether you use this machine on a DHCP environment or not. Set this item to “NONE” when a fixed IP address is assigned to this machine on the network you use. Set this item to “DHCP” when you use this machine on a DHCP environment.

 **Note**

- If you plan to use delivery server function, assign an IP address of this machine statically, even when you use this machine on a DHCP environment. You still have to select “DHCP” for **[Network Boot]**, and do not enter any value to the following setup items: **[IP Address]**, **[Subnet Mask]**, **[Default Gateway Address]**.
- After you have changed the setting of this item, turn off the power and then back on to activate the change.

❖ **DNS Server 1 IP Address**

Specify the IP address of the primary DNS server on the network you use this machine, in the form of xxx.xxx.xxx.xxx (xxx:0 through 255).

 **Note**

- This setting can only be configured using the Web Status Monitor.

❖ **DNS Server 2 IP Address**

When a secondary DNS server runs on the network you use this machine, specify the IP address of the secondary DNS server in the form of xxx.xxx.xxx.xxx (xxx:0 through 255).

 **Note**

- This setting can only be configured using the Web Status Monitor.

❖ **DNS Server 3 IP Address**

When a third DNS server runs on the network you use this machine, specify the IP address of the third DNS server in the form of xxx.xxx.xxx.xxx (xxx:0 through 255).

 **Note**

- This setting can only be configured using the Web Status Monitor.

❖ **Delivery Server IP Address**

This item is automatically configured when you register this machine to a delivery server operated by ScanRouter V2 Professional/Lite. Do not specify this item manually.

❖ **Transmission Speed**

Use this item to select a network transmission speed from “Auto”, “100Mbps” or “10Mbps” when you connect this machine to a network using a cable.

❖ **LAN Type**

Use this item to select the type of LAN from the following options.

- Ethernet
Select this option when you connect this machine to a network using a cable.
- IEEE 802.11b
Select this option when you connect this machine to a network using an optional wireless LAN card.

 **Note**

- After you have changed the setting of this item, turn off the power and then back on to activate the change.

Configuring [System Settings]

Reference

See p.15 "Using Keys Displayed on the Screen" for information about how to select items displayed on the screen.

1 Press the **[User Tools]** key.

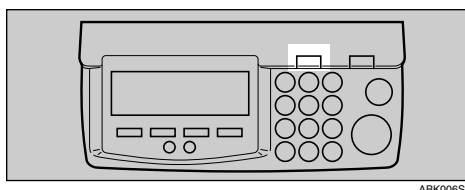

The Scanner Features menu is displayed.

2 Press the **[1]** key.

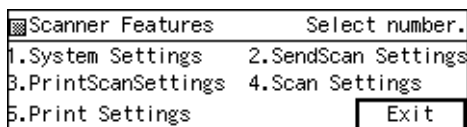

The System Settings menu is displayed, and "1. Function Priority" appears as the setup item currently selected.

3 Press **[OK]**.

The setting screen for "1. Function Priority" appears.

Note

- Pressing **[PrevMenu]** returns to the parent menu screen.

4 Select the option you want among "Select: Send/Print", "Send Scan" and "Print Scan".

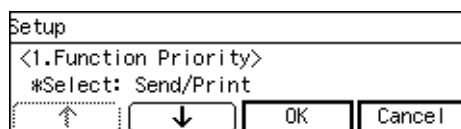

- The option that is currently selected is displayed first.
- "*" mark appears along with the option currently selected
- Use **[↑]** and **[↓]** to display the option you want to select.

5 While the option you want to select is displayed, press **[OK]**.

This saves the setting you have configured, and returns to the System Settings menu.

Note

- Pressing **[Cancel]** discards the selected option, and returns to the previous screen.

6 Configure the necessary settings in accordance with your network environment.

To configure network boot and related settings when a fixed IP address is assigned to this machine

1 Press **[Next]**.

"2. IP Address" appears as the setup item currently selected.

2 Press **[OK]**.

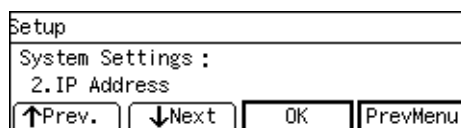

The setting screen for "2. IP Address" appears.

3 Specify the IP address of this machine.

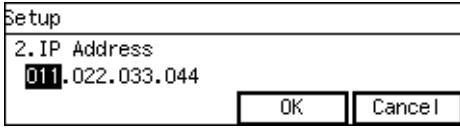

- Input the IP address using the number keys.
- An IP address consists of four parts, and each part has a number within the range of 0 to 255. Make sure that you input each part of the IP address in three digits. For example, when you want to specify “8” for a part, highlight the part and then input “008” using the number keys.
You can use **[▶1]** (or **[#]**) and **[◀]** keys to move the highlighting to right and left.

Note

- You can use the **[Clear/Stop]** key to clear the three-digit number currently highlighted.

4 When you are finished, press [OK].

This returns to the System Settings menu.

Note

- Pressing **[Cancel]** discards the value that you have specified, and returns to the previous screen.

5 Press [Next]

“3. Subnet Mask ” appears as the setup item currently selected.

6 Specify each value for “3. Subnet Mask ”, “4. Default Gateway Address ”, “5. Access Control ” and “6. Access Mask ” in the same way that you have done in steps 2 through 5.

“7. Network Boot ” appears as the setup item currently selected.

Note

- When you want to set no limitation of access to this machine, it is not necessary to specify “5. Access Control ”, while you need to confirm that “6. Access Mask ” is set to “000.000.000.000”.

7 Press [OK].

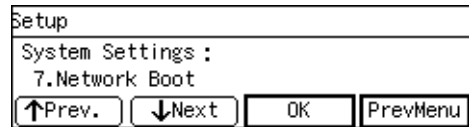

The setting screen for “7. Network Boot ” appears.

8 Use [↑] and [↓] to display “NONE”.

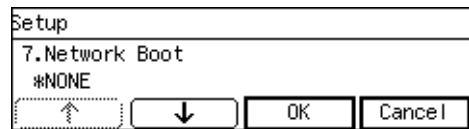

Note

- “*” mark appears along with the option currently selected.

9 While “NONE” is displayed, press [OK].

This returns to the System Settings menu.

Note

- Pressing **[Cancel]** leaves the setting as it was (the option marked with “*” remains active), and returns to the previous screen.

To configure network boot settings when you use this machine on a DHCP environment

1 Press [Next] three times.

“5. Access Control ” appears as the setup item currently selected.

Note

- It is not necessary to specify “2. IP Address ”, “3. Subnet Mask ” and “4. Default Gateway Address ”. The DHCP server on your network assigns these values automatically.

2 Specify each value for “5. Access Control ” and “6. Network Boot ”.

You can specify these values in the same way that you have done in steps **2** through **5** under p.55 “To configure network boot and related settings when a fixed IP address is assigned to this machine”. When you are finished, “7. Network Boot ” appears as the setup item currently selected.

Note

- When you want to set no limitation of access to this machine, it is not necessary to specify “5. Access Control ”, while you need to confirm that “6. Access Mask ” is set to “000.000.000.000”.

3 Press [OK].

Setup
System Settings :
7.Network Boot
<input type="button" value="↑Prev."/> <input type="button" value="↓Next"/> <input type="button" value="OK"/> <input type="button" value="PrevMenu"/>

The setting screen for “7. Network Boot ” appears.

4 Use [↑] and [↓] to display “ DHCP ”.

Setup
7.Network Boot
DHCP
<input type="button" value="↑"/> <input type="button" value="↓"/> <input type="button" value="OK"/> <input type="button" value="Cancel"/>

Note

- “*” mark appears along with the option currently selected.

5 While “ DHCP ” is displayed, press [OK].

This returns to the System Settings menu.

Note

- Pressing [Cancel] leaves the setting as it was (the option marked with “*” remains active), and returns to the previous screen.

7 Press [Next].

Setup
System Settings :
7.Network Boot
<input type="button" value="↑Prev."/> <input type="button" value="↓Next"/> <input type="button" value="OK"/> <input type="button" value="PrevMenu"/>

“8. Delivery Server IP Address ” appears as the setup item currently selected.

Note

- This item is automatically configured when you register this machine to a delivery server operated by ScanRouter V2 Professional/Lite. Press [OK] to confirm this setting after you have registered this machine to a delivery server, and then press [Cancel] to return to the System Settings menu.

8 Press [Next].



“9. MAC Address ” appears as the setup item currently selected.

Note

- MAC address is a hardware address that uniquely identifies each machine, and cannot be changed. Press [OK] to see the MAC address of this machine, and then press [Cancel] to return to the System Settings menu.

9 By pressing [Next] to display “10. Transmission Speed ” and “11. LAN Type ” as the setup item, select options for each of them in the same way that you have done for setting “7. Network Boot ”.

Important

- Do not change the setting of “11. LAN Type ” from “ Ethernet ” to “ IEEE 802.11b ” using the control panel of this machine. If you want to change to “IEEE802.11b” to use a wireless LAN card, you need to configure related settings by using the Web Status Monitor. See p.186 “Using Wireless LAN” for details.

10 Press [Next].

“12. Wireless LAN Signal ” appears as the setup item currently selected.

Note

- When an optional wireless LAN card is in use under infrastructure mode, you can check current condition of wireless LAN signal by pressing [OK]. When you are finished, press [Cancel] to return to the System Settings menu.

11 Press [PrevMenu]

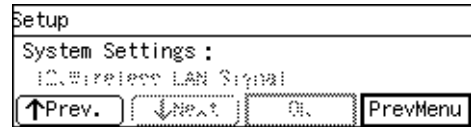

This returns to the Scanner Features menu.

12 Press [Exit].

This exits the Scanner Features menu, and returns to the standby screen that is displayed when you turn the power on.

Important

- Never turn off the power of this machine before the standby screen is displayed. Doing so can discard all the settings you have configured, and return this machine to its factory default status.

Note

- Instead of pressing [Exit], you can press a number key to enter another setting menu.

13 If you have changed the settings of “7. Network Boot ” and/or “11. LAN Type ”, turn off the power and then back on.

The changes to the above settings are activated.

Scanner Settings

This section describes the setup items contained in the Scanner Settings, and shows you how to configure the settings in the Send Scan Settings menu (which includes main setup items in the Scanner Settings) using the control panel of this machine.

Information to Set in [System Settings]

❖ 1. Select Method

This item lets you select which of the functions of this machine has priority, when you use this machine. You can select from the following two options.

- TWAIN

With this option, the Network TWAIN standby screen is displayed as the Send Scan initial screen. This means that the machine stands by for receiving a scanning command from a client computer. While the Network TWAIN standby screen is displayed, press **[Exit]** to use the Delivery Server function or the Send Mail/Send File function (except for performing a Custom File Send operation).

- Send File

With this option, the Delivery Server standby screen or the E-mail/Send File standby screen is displayed as the Send Scan initial screen. While either of these screens is displayed, you can use this machine as a network TWAIN scanner or perform a Custom File Send operation from a client computer, whenever no operation is performed on this machine.

Note

- When you set “7. Select Method” to “TWAIN”, this setup item is dimmed and cannot be configured.

❖ TWAIN Standby Time

This item lets you specify the time after which this machine stands by for a network TWAIN command (or a **[Enter Custom Send File]** command), from the last operation of the control panel of this machine. When you set this item to “Off”, this machine always stands by for these commands. When you set this item to “On”, you can set the time within the range of 3 to 30 seconds in 1-second increments.

Note

- When this machine receives a network TWAIN command (or a **[Enter Custom Send File]** command) before the specified TWAIN standby time goes by, the message “Unable to make configurations because Scanner is currently in use. Please try again later.” appears on the client computer.

❖ Auto Reset Timer

This item lets you select whether to return to the state immediately after power-on when this machine is not used for the specified time period. When you set this item to “Off”, the screen currently displayed remains until another operation is performed or the power is turned off. When you set this item to “On”, you can set the time within the range of 10 to 999 seconds in 1-second increments.

❖ **Date/Time(Year/Month/Day/Hr/Min/Sec)**

This item lets you adjust the machine's date and time.

The current date and time affects all the related operations of this machine, such as a time stamp inserted in each of e-mail messages sent from this machine.

❖ **Compression (Black and White)**

This item determines whether to compress scan data, created under the following conditions.

- Scan is performed for sending the scan data using Delivery Server function or Send Mail/Send File function.
- Scan is performed with one of the following options is selected for **[Scan Settings]** → **[Scan Type]** : " Black and White:Text ", " Black and White:Text/Photo ", or " Black and White:Photo ".

 **Note**

- Compressing data increases the number of original pages that can be processed at a time. The number of original pages changes depending on the status of the originals.
- When not compressing scanned data, file size is determined by the scanning size and resolution, regardless of the status of the original. See p.200 "When [Black and White: Text], [Black and White: Text/Photo] or [Black and White: Photo] is selected".

❖ **Compression (Gray Scale/Full Colour)**

This item determines whether to compress scan data, created under the following conditions.

- Scan is performed for sending the scan data using Delivery Server function or Send Mail/Send File function.
- Scan is performed with one of the following options is selected for **[Scan Settings]** → **[Scan Type]** : " Black and White:Gray Scale " or " Colour:Full Colour ".

You can select from the following four options. JPEG compression is performed when you select any of the compression options.

- **Normal Compression**
Intermediate compression is performed with the scan data, and intermediate file size and image quality can be obtained.
- **High Compression**
Higher compression is performed with the scan data so that the file size becomes much smaller, while the image quality gets relatively lower (in comparison with normal compression).
- **Low Compression**
Lower compression is performed with the scan data so that the image quality becomes relatively higher, while the file size gets larger (in comparison with normal compression).
- **Off**
Scanned data is not compressed. Quality is not lost, but file size and memory usage increase. File size is determined by the scanning size and resolution, regardless of the status of the original.

 **Note**

- The size of compressed data varies among originals even if the same quality setting is made for them. The number of original pages that can be processed at a time also varies.

❖ **7. Select Method**

You can select a method that suits for a combination of the functions you want to use when you perform a Send Scan operation. The following three options are available.

- **Delivery Server/TWAIN**
Select this option if you want to use Delivery Server and network TWAIN.
- **Send File/TWAIN**
Select this option if you want to use e-mail, Send File (SMB), Send File (FTP), and network TWAIN.
- **TWAIN**
Select this option if you want to use Network TWAIN only.

❖ **Auto Update Destination List**

- When " Delivery Server/TWAIN " is selected under **[7.Select Method]**
Select whether to update the contents of the Address Book automatically with the latest data from the delivery server. When " On " is selected, the Address Book is updated each time you press **[Dest.]** or **[Sender]** on this machine. When " Off " is selected, the Address Book is updated only when the power is turned on.

- When " Send File/TWAIN " is selected under **[7.Select Method]**
Select whether to update the contents of the destination lists of e-mail addresses, file send paths, and FTP servers automatically with the latest data registered using the Web Status Monitor's **[E-mail Address]**, **[File Send Path]** and **[FTP Server]**.
When " On " is selected, the destination list is updated each time you press **[Dest.]** or **[Sender]** on this machine. When " Off " is selected, the destination list is updated only when the power is turned on.

 **Note**

- You can select " Off " if you do not plan to update the Address Book or the destination lists frequently. Selecting " Off " makes this machine react quickly when you press **[Dest.]** or **[Sender]**.

❖ **Unit of Measure**

This item lets you select a unit of measurement that is used when you specify values for **[Custom Size]** of **[Original Size]** setting. You can select between "mm" and "inch".

❖ **sRGB**

This item lets you select whether to scan originals with the sRGB Colour matching function enabled. This function is available only when you select " Colour:Full Colour " in **[Scan Type]** under **[Scan Settings]**.

- When " Off " is selected, the sRGB Colour matching function is disabled.
- When " sRGB 1 " is selected, the original's Colour tone is accurately reproduced, but the paper's yellowish tone may be reproduced also.

- Selecting “ sRGB 2” reduces the paper's yellowish tone.

Note

- Selecting “ sRGB 1” or “ sRGB 2” disables the **[Image Density]** setting. (⇒ p.72)

❖ End of Scan Option

This item lets you select how this machine behaves after a scanning operation ends. The option selected for this item applies scanning performed in a Send Scan (Delivery Server or Send Mail/Send File) operation.

Note

- You can perform additional scan operation after a scanning from the exposure glass is finished, regardless of the setting of this item.
- When you perform a Print Scan operation, the option selected for this setup item does not apply.

• **Show Options after Each Scan Job**

The screen for selecting the next operation appears on the display panel of this machine.

When scanning is performed from the ADF

The following screen appears when all the originals in the ADF are scanned.

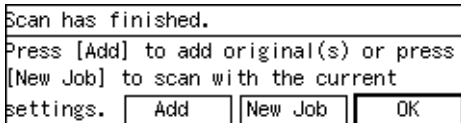

- Press **[Add]** to continue scanning to add scanned data to the current image file.

- Pressing **[New Job]** finishes the current scanning job and sends the scanned data. You can start a new job with the current settings after the scanned data is sent.

- Pressing **[OK]** finishes the current scanning job, sends the scanned data, and then returns to the initial screen when the power is turned on.

When scanning is performed from the exposure glass

The following screen appears when you press **[Finish]** after scanning the original on the exposure glass.

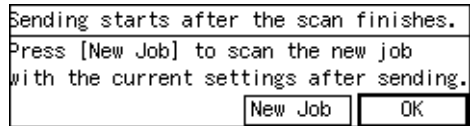

- Pressing **[New Job]** finishes the current scanning job and sends the scanned data. You can start a new job with the current settings after the scanned data is sent.

- Pressing **[OK]** finishes the current scanning job, sends the scanned data, and then returns to the initial screen when the power is turned on.

Note

- You can specify the time during which the screen for selecting the next operation remains displayed using **[Configuration] → [Basic Settings] → [Scanner] → [Wait Time for Additional Scanning]** on the Web Status Monitor. See the Web Status Monitor Help.

- ❑ When you perform an **[Enter Custom Send File]** operation from the Web Status Monitor, selecting **[New Job]** and **[OK]** on the selection screen both finishes the current scanning job, sends the scanned data, and the **[Enter Custom Send File]** settings are retained. Press **[PrevMenu]** to return to the initial screen when the power is turned on.

Ready	[SMB]	[All]
[1/1]001Jane		
Dens. 4, B&W: Text	, 100dpi	, Auto
Scan	Dest.	Sender
		PrevMenu

- **Clear Settings after Each Scan Job**

The initial screen displayed immediately after power-on appears on the display panel of this machine, and files are sent.

 **Note**

- ❑ When you perform an **[Enter Custom Send File]** operation from the Web Status Monitor, the **[Enter Custom Send File]** settings are retained after files are sent. Press **[PrevMenu]** to return to the initial screen when the power is turned on.

- ❖ **Erase Border**

When you perform a scan operation, it may happen that a borderline is reproduced on scan data by the shadow of paper ends of the original. This machine can erase the borderline using a white line, which width you can specify using **[Erase Border]**. You can select a line width from 1mm (0.04") to 5mm (0.2"). Select "0mm" if you do not want to have the borderline erased. The option selected for this item applies scanning performed in a Send Scan (Delivery Server or Send Mail/Send File) operation.

- ❖ **Select Language**

This item lets you select a language for displaying messages on the screen.

- ❖ **ADF Thin Paper**

This item lets you select how the ADF works.

- **On**
Select this option when you scan originals that are 52g/m² (45kg) or thinner, or A5 size or smaller, using the ADF. With this option, feeding becomes stable even when you place such originals as mentioned above in the ADF. However, feeding becomes rather slower.
- **Off**
Select this option when you scan the originals other than those of mentioned in the "On" option. The ADF works at its highest speed when you select this option.

- 🔍 **Reference**

See the notes under p.109 "Sizes and Weights of recommended Originals".

❖ **Job Delivery Data Max. Setting**

This item lets you select whether to limit the maximum file size of a document to be sent by using the delivery server. When you set limitation of the size, you can specify it within the range of 1 MB to 64 MB, in 1MB increments.

 **Note**

- You can also configure this setting by selecting **[Configuration]** → **[Delivery Settings]** → **[Delivery]** on the Web Status Monitor.

❖ **Wait Time for Additional Scanning**

When “Show options after each scan job” is selected for **[End of Scan Option]**, enter the time during which the setting menu appears. Specify the time in seconds within the range of 3 through 900. When the specified time elapses, the initial screen displayed immediately after power-on appears on the control panel and files are sent.

 **Note**

- This setting can only be configured using the Web Status Monitor.

❖ **Select Title**

This item lets you select the titles that are displayed when you press the **[./*]** (Title) key. You can select between “Alphabet” and “Custom Title”.

 **Note**

- This setting can only be configured using the Web Status Monitor.
- Before using “Custom Title”, it is necessary to register custom titles using the Web Status Monitor, and restart this machine.

❖ **Time Zone**

This item lets you specify your local time zone, by selecting the time offset from GMT (Greenwich Mean Time).

 **Note**

- This setting can only be configured using the Web Status Monitor.

Configuring [Send Scan Settings]

Follow the steps below to configure Send Scan Settings using the control panel of this machine.

 **Note**

- You can also configure these settings using the Web Status Monitor.

 **Reference**

See p.15 “Using Keys Displayed on the Screen” for information about how to select items displayed on the screen.

1 Press the **[User Tools]**

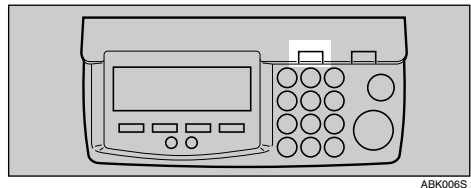

The Scanner Features menu is displayed.

2 Press the **[2]** key.

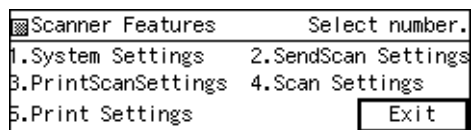

The Send Scan Settings menu is displayed, and “1. Select Method” appears as the setup item currently selected.

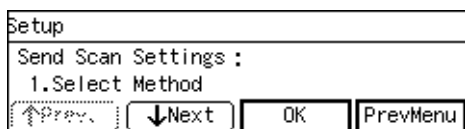
3 Press [OK]

The setting screen for “1. Select Method ” appears.

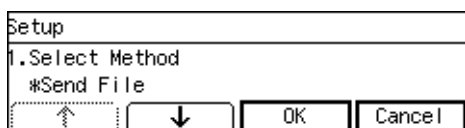
4 Select the function that you mainly use from “ Send File ” or “ TWAIN ”.

- The option that is currently selected is displayed first.
- “*” mark appears along with the option currently selected.
- Use [↑] and [↓] to display the option you want to select.

5 Press [OK].

This saves the setting you have made, and returns to the Send Scan Settings menu.

Note

- Pressing [Cancel] discards the selected option, and returns to the previous screen.

6 Press [Next].

“2. TWAIN Standby Time ” appears as the setup item currently selected.

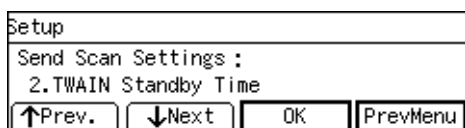
7 Press [OK].

The setting screen for “2. TWAIN Standby Time ” appears.

8 Select the option you want for “2. TWAIN Standby Time ”.

If you select “ On ”, specify the time after which this machine stands by for a network TWAIN command (or a [Enter Custom Send File] command) using the number keys.

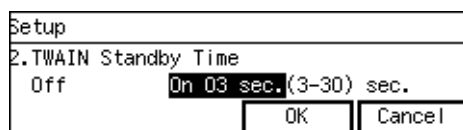

- Use the [▶] and [◀] keys to highlight the setting you want.

Note

- To correct the number, press the [Clear/Stop] key to clear the number you have entered.

9 Press [OK]

This saves the setting you have configured, and returns to the Send Scan Settings menu.

Note

- Pressing [Cancel] discards the selected option, and returns to the previous screen.

10 Press [Next].

“3. Auto Reset Timer ” appears as the setup item currently selected.

Note

- Pressing [Prev.] displays the previous setup item.

11 Set the auto reset timer in the same way that you have done in the steps **7** through **10**.

“4. Date/Time(Year/Month/Day/Hr/Min/Sec) ” appears as the setup item currently selected.

12 Press [OK].



The setting screen for “4. Date/Time(Year/Month/Day/Hr /Min/Sec) ” appears.

13 Use the [▶] and [◀] keys and the number keys to adjust the current date and time.



Note

- The internal clock starts working from the adjusted time when you press [OK].
- To correct the number that is currently highlighted, press the [Clear/Stop] key to clear the number you have entered, and then input the correct number.

14 Press [OK].

This returns to the Send Scan Settings menu.

Note

- Pressing [Cancel] discards the adjusted time value, and returns to the previous screen.

15 By pressing [Next] to display “5. Compression (Black and White) ” through “14. ADF Thin Paper ” as the setup item, select options for each of them in the same way that you have done in the steps **3** through **5**.

After all, “15. Job Delivery Data Max. Setting ” appears as the setup item currently selected.

16 Select the option you want for “15. Job Delivery Data Max. Setting ” in the same way that you have done in the steps **7** through **9**.

17 Press [PrevMenu].

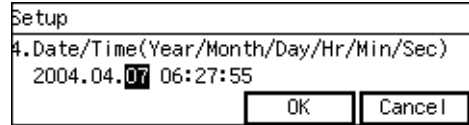

This returns to the Scanner Features menu.

18 Press [Exit].

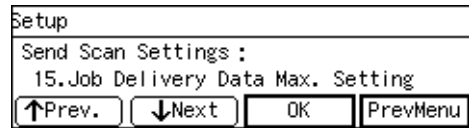

This exits the Scanner Features menu, and returns to the standby screen that is displayed when you turn the power on.

Important

- Never turn off the power of this machine before the standby screen is displayed. Doing so can discard all the settings you have configured, and return this machine to its factory default status.

Note

- Instead of pressing [Exit], you can press a number key to enter another setting menu.

Print Scan Settings

This section describes all the setup items included in Print Scan Settings menu, and shows you how to configure these settings using the control panel of this machine.

Information to Set in [Print Scan Settings]

❖ Max. Number of Copies

This item lets you set an upper limit for the number of copies that you can specify when you perform a Print Scan operation, within the range of 1 to 999.

Note

- You can also configure this setting by selecting **[Configuration]** → **[Print Scan Settings]** → **[Print Scan]** on the Web Status Monitor.

❖ Colour/Black and White

This item lets you select default scan setting for Print Scan, between " Colour " and " Black and White ".

- Colour
The original is scanned with full colour. With this option, you will have copies in colour when you use a colour printer, or copies in black and white when you use a monochrome printer.
- Black and White
The original is scanned with black and white or with gray scale.

Note

- Scan is performed with black and white or in gray scale, depending on the setting you have configured in the Print Settings menu. If you select " Text " as **[Scan Type]** in the Print Settings menu, scan is performed with black and white. If you select " Text/Photo " or " Photo ", scan is performed with gray scale.

Configuring [Print Scan Settings]

Follow the steps below to configure Print Scan Settings using the control panel of this machine.

Note

- You can also configure these settings using the Web Status Monitor.

Reference

See p.15 "Using Keys Displayed on the Screen" for information about how to select items displayed on the screen.

1 Press the **[User Tools]** key.

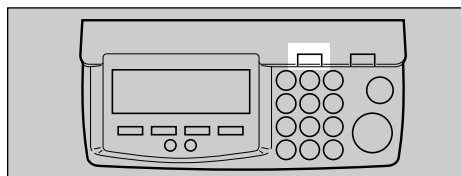

ABK006S

The Scanner Features menu is displayed.

2 Press the **[3]** key.

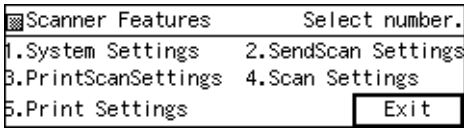

The Print Scan Settings menu is displayed, and "1. Max. Number of Copies" appears as the setup item currently selected.

3 Press **[OK]**.

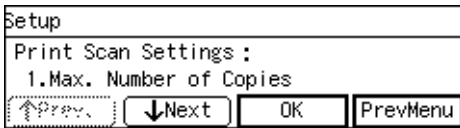

The setting screen for "1. Max. Number of Copies" appears.

Note

- Pressing **[PrevMenu]** returns to the parent menu screen.

4 Input maximum number of copies you want to set using the number keys.

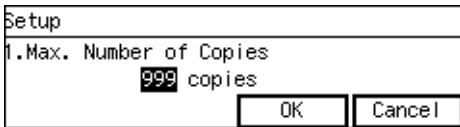

Note

- To correct the number, press **[Clear/Stop]** key to clear the number you have entered.

5 Press **[OK]**.

This saves the setting you have made, and returns to the Print Scan Settings menu.

Note

- Pressing **[Cancel]** discards the entered value, and returns to the previous screen.

6 Press **[Next]**.

"2. Colour/Black and White" appears as the setup item currently selected.

7 Press **[OK]**.

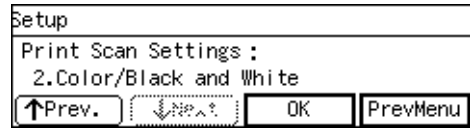

The setting screen for "2. Colour/Black and White" appears.

8 Select "Color" or "Colour/Black and White".

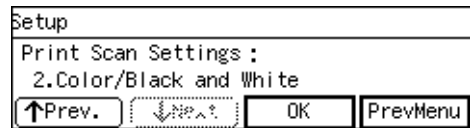

- The option that is currently selected is displayed first.
- "*" mark appears along with the option currently selected.
- Use **[↑]** and **[↓]** to display the option you want to select.

9 While the option you want to select is displayed, press **[OK]**.

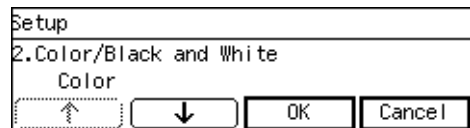

This saves the setting you have configured, and returns to the Print Scan Settings menu.

Note

- Pressing **[Cancel]** discards the selected option, and returns to the previous screen.

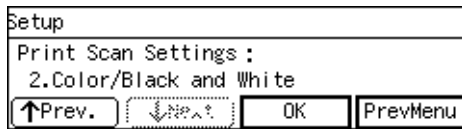
10 Press **[PrevMenu]**.

This returns to the Scanner Features menu.

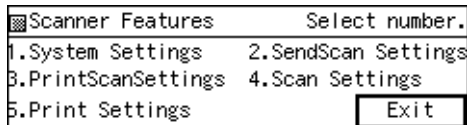
11 Press **[Exit]**.

This exits the Scanner Features menu, and returns to the standby screen that is displayed when you turn the power on.

Important

- Never turn off the power of this machine before the standby screen is displayed. Doing so can discard all the settings you have configured, and return this machine to its factory default status.

Note

- Instead of pressing **[Exit]**, you can press a number key to enter another setting menu.

Registering Scan Settings

You can configure and register up to four sets of settings for scanning, when performing a Send Scan (e-mail, Send File (SMB/FTP) or Delivery Server) operation.

Memory areas named “ Default ”, “ User 1”, “ User 2”, and “ User 3” are available for registering Scan Settings. You can easily recall the settings you have registered to “ User 1”, “ User 2”, or “ User 3”, which means you don’t have to configure detailed settings each time you send scan data. Settings registered to “ Default ” apply when you send scan data without selecting “ User 1”, “ User 2”, or “ User 3”, or without manually configuring Scan Settings.

3

Information to Register in [Send Scan Settings]

❖ Scan Type

This item lets you select a scan type. The number of colours and gradation levels are automatically selected according to the selected scan type.

- **Black and White:Text**
Scans standard originals containing mainly text as black-and-white binary images.
- **Black and White:Text/Photo**
Scans originals containing graphs, photos, and text as black-and-white binary images.
- **Black and White:Photo**
Scans originals containing mainly black-and-white photos and graphs as black-and-white binary images.

- **Black and White:Gray Scale**
Scans originals containing mainly black-and-white photos, and colour photos as black-and-white photos.
Selecting [**Gray Scale**] reduces the number of original pages that can be scanned at a time.
- **Colour:Text**
Scans standard originals containing mainly text as colour images.
- **Colour:Text/Photo**
Scans originals containing graphs, photos, and text as colour images.
- **Colour:Photo**
Scans originals containing mainly colour photos and graphs as colour images.
- **Colour:Full Colour**
Scans high-definition colour photos.

Note

- Selecting [**Colour:Full Colour**] reduces the number of original pages that can be scanned at a time.

❖ Resolution

This item lets you select the scan resolution. You can select from 100dpi, 200dpi, 300dpi, 400dpi, 600dpi and [**Custom Resolution**].

Note

- The higher the resolution, the smaller the number of original pages that can be scanned at a time.

- When you select [**Custom Resolution**], you can specify the resolution within the range of 100dpi through 1200dpi in 1dpi increments.

❖ Scan Size

This item lets you select the size of the area to be scanned. You can select from the following options.

Auto Detect, A3☐, A4☐, A4☐, A5☐, A5☐, 11x17☐, 8¹/₂x14☐, 8¹/₂x13☐, 8¹/₂x11☐☐, 8¹/₂x11☐, 5¹/₂x8¹/₂☐, 5¹/₂x8¹/₂☐, B4JIS (Japanese Industrial Standard)☐, B5JIS☐, B5JIS☐, Custom Area Setting

📌 Note

- Original sizes that can be auto-detected vary depending on where you place the originals (on the exposure glass or on the ADF). See ⇒ p.110 “The Original Sizes Available for Auto Detection” for details.
- When [**Custom Area Setting**] is selected, specify the scanning area for [**Start Positn.**] and [**Scanning Area**].

❖ Position

Specify the position where scanning starts when [**Custom Area Setting**] is selected in the [**Scan Size**] list.

Enter the offset from the reference (start) point in millimeters or inches.

📌 Note

- This setting is enabled only when [**Custom Area Setting**] is selected in the [**Scan Size**] list.
- You can select millimeters or inches to specify the position using [**Unit of Measure**] in [**2.Send-Scan Settings**] under the Scanner Features menu. See ⇒ p.61 “Unit of Measure” for details.

❖ Scanning Area

Specify the position where scanning ends when [**Custom Area Setting**] is selected in the [**Scan Size**] list.

Enter the offset from the position specified for [**Start Positn.**], in millimeters or inches.

📌 Note

- This setting is enabled only when [**Custom Area Setting**] is selected in the [**Scan Size**] list.
- You can select millimeters or inches to specify the position using [**Unit of Measure**] in [**2.Send-Scan Settings**] under the Scanner Features menu. See p.61 “Unit of Measure” for details.
- Make sure that you specify vertical/horizontal positions and scanning areas to be within the available scan area. The available scan area varies depending on where you place the originals (on the exposure glass or on the ADF).

The following illustrates the reference point and actual scanning area in accordance with the place where you set the originals.

- ① When the document is set in document glass

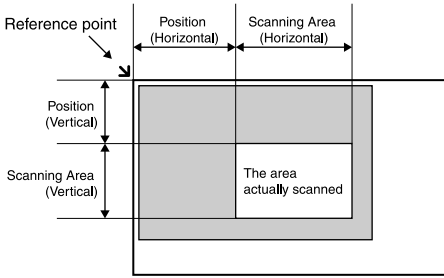

ADG012S

When you place the originals on the exposure glass, the available area for scanning is 300mm (11.8") (vertical) and 432mm (17") (horizontal) from the reference point, regardless of the setting in [Scan Type]. Be sure to specify [Position] and [Scanning Area] to be within the available area for scanning.

- ② When you place the originals in the ADF

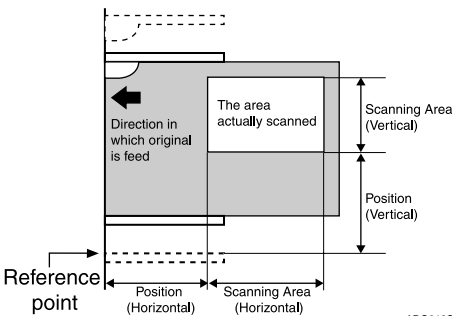

ADG013S

When you place the originals in the ADF, the available area for scanning is as follows depending on the setting in [Scan Type] and [Original Settings].

- When [Scan Type] is set to "Black and White:Text ", "Black and White:Text/Photo " or "Black and White:Photo " and [Original Settings] is set to a 1-sided option: 297mm (11.7") (vertical) and 2000mm (78.7") (horizontal) from the reference point
- When [Scan Type] is set to other than the above, and [Original Settings] is set to a 1-sided option: 297mm (11.7") (vertical) and 630mm (24.8") (horizontal) from the reference point
- When [Original Settings] is set to a 2-sided option: 297mm (11.7") (vertical) and 432mm (17") (horizontal) from the reference point

Be sure to specify [Position] and [Scanning Area] to be within the available area for scanning.

Note

- ❑ The inside line of the original table's guide on the side of the control panel exactly passes the vertical reference point for the ADF scanning, when the guide is fully expanded.

Image Density

This item lets you select the scan density in one of the seven steps. The larger the value, the darker the scanned image becomes.

❖ Erase Colour

This setting is available only when “ Black and White:Text ”, “ Black and White:Text/Photo ”, “ Black and White:Photo ”, or “ Black and White:Gray Scale ” is selected in the [**Scan Type**] list. You can select an erase colour from red, green, or blue, which colour is deleted (ignored) when scanning is performed. Select “ Off ” when you want to disable erase colour.

Note

- The erase colour function may not work as expected depending on the colours on the originals.

❖ Noise Reduction

This item lets you select the size of spots erased from the scanned image as unwanted noise. Spot size is indicated in dots. When [Off] is selected, all small spots are scanned.

Note

- The numbers in each of the options (“3x3”, “4x4”, and “5x5”) stand for the minimum range of detecting isolated dots on the original. All the isolated dots that are fully covered by the specified range are erased, in accordance with the option you select.

❖ Edge Smoothing

This item lets you select whether to enable or disable edge smoothing, when “ Black and White:Text ”, “ Black and White:Text/Photo ”, or “ Black and White:Photo ” is selected in the [**Scan Type**] list.

When “ On ” is selected for this item, text and graphics are scanned with their edges smoothed.

❖ Filter

This item lets you select whether to use a filter for scanning.

- Off
No filter for scanning.
- MTF
Images are scanned with sharpened borders.
- Fine Noise
Images are scanned with softened borders.

❖ Inversion

This item lets you select whether to scan an original with white and black portions inverted, when “ Black and White:Text ”, “ Black and White:Text/Photo ”, “ Black and White:Photo ”, or “ Black and White:Gray Scale ” is selected in the [**Scan Type**] list.

❖ File Type

This item lets you select the format for saving scanned images. The option you select for this setup item affects the send file operations, including sending a file as an e-mail attachment, sending a file to an Windows shared folder, and sending a file to an FTP server.

Note

- When a send file operation is performed using the delivery server function, the file type is determined in accordance with the delivery server setting.
- Single Page
Each page is saved as a single, separate file. When an original of two or more pages is scanned, the same number of files as the number of original pages is created.

Note

□ When “ Black and White:Gray Scale ” or “ Colour:Full Colour ” is selected in the [**Scan Type**] list, and “ High Compression ”, “ Normal Compression ”, or “ Low Compression ” is selected in the [**Compression (Gray Scale/Full Colour)**] list under [**System Settings**], the scanned image is saved as a JPEG file. Otherwise, it is saved as a TIFF file.

- PDF
The scanned image is saved as a PDF file.
- Multi-page TIFF
An original of two or more pages is saved as one file. When “ Black and White:Gray Scale ” or “ Colour:Full Colour ” is selected in the [**Scan Type**] list, and “ High Compression ”, “ Normal Compression ”, or “ Low Compression ” is selected in the [**Compression (Gray Scale/Full Colour)**] list under [**System Settings**], the scanned image is saved as a PDF file. Otherwise, it is saved as a TIFF file.

❖ **Original Settings**

This item lets you select the orientation of the original, and whether to scan one side or both sides of the original. See p.112 “Original Orientation” for details.

Registering [Scan Settings]

Follow the steps below to configure and register Scan Settings using the control panel of this machine.

Note

□ You can also configure these settings using the Web Status Monitor.

Reference

See p.15 “Using Keys Displayed on the Screen” for information about how to select items displayed on the screen.

1 Press the [**User Tools**] key.

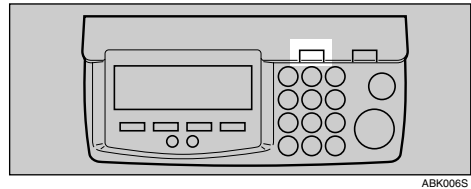

The Scanner Features menu is displayed.

2 Press the [**4**] key.

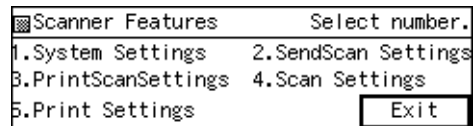

The Scan Settings menu is displayed.

On this menu, you can select a memory area (“ Default ”, “ User 1”, “ User 2”, or “ User 3”) for registering the Scan Settings configuration.

3 Press the **[1]** key.

Scan Settings		Select number.
1.Default	2.User 1	
3.User 2	4.User 3	

PrevMenu

The Default Scan Settings menu is displayed, and "1. Scan Type" appears as the setup item currently selected.

4 Press **[OK]**.

Scan Settings		Select number.
1.Default	2.User 1	
3.User 2	4.User 3	

PrevMenu

The setting screen for "1. Scan Type" appears.

Note

- Pressing **[PrevMenu]** returns to the parent menu screen.

5 Select scan type.

Setup	
Default Scan Settings : 1.Scan Type	
*Black and White : Text	

- The option that is currently selected is displayed first.
- "*" mark appears along with the option currently selected.
- Use **[↑]** and **[↓]** to display the option you want to select.

6 While the option you want to select is displayed, press **[OK]**.

This saves the setting you have selected, and returns to the Default Scan Settings menu.

Note

- Pressing **[Cancel]** discards the selected option, and returns to the Default Scan Settings menu.

7 Press **[Next]**.

"2. Resolution" appears as the setup item currently selected.

Note

- Pressing **[Prev.]** displays the previous setup item.

8 Press **[OK]**.

Setup	
Default Scan Settings :	
2.Resolution	

The setting screen for "2. Resolution" appears.

9 Select the resolution you want.

Setup	
Default Scan Settings : 2.Resolution	
*100 dpi	

- The option that is currently selected is displayed first.
- "*" mark appears along with the option currently selected.
- Use **[↑]** and **[↓]** to display the option you want to select.

To select a preset resolution

1 While the preset resolution you want to select is displayed, press **[OK]**.

This saves the setting you have selected, and returns to the Default Scan Settings menu.

Note

- Pressing **[Cancel]** discards the selected option, and returns to the Default Scan Settings menu.

To specify the resolution manually using **[Custom Resolution]**

1 While **[Custom Resolution]** is displayed, press **[Setting]**.

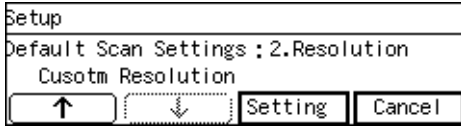

The setting screen for “ Custom Resolution ” appears.

2 Specify the resolution manually by using the number keys.

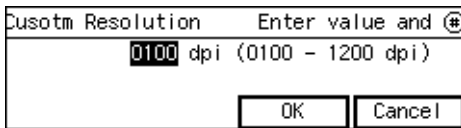

Note

- To correct the number, press the **[Clear/Stop]** key to clear the number you have entered.

3 Press **[OK]**.

This saves the setting you have entered, and returns to the Default Scan Settings menu.

Note

- Pressing **[Cancel]** discards the values you have entered, and returns to the Default Scan Settings menu.

10 Press **[Next]**.

“3. Scan Size ” appears as the setup item currently selected.

11 Press **[OK]**.

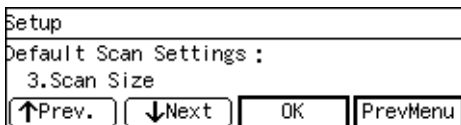

The setting screen for “3. Scan Size ” appears.

12 Select the Scan size.

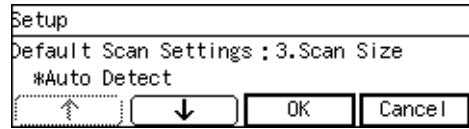

- The option that is currently selected is displayed first.
- “*” mark appears along with the option currently selected.
- Use **[↑]** and **[↓]** to display the option you want to select.

To select a scan size from preset sizes

1 While the preset scan size you want to select is displayed, press **[OK]**.

This saves the setting you have selected, and returns to the Default Scan Settings menu.

Note

- Pressing **[Cancel]** discards the selected option, and returns to the Default Scan Settings menu.

To set a custom area

1 While the option “ Custom Area Setting ” is displayed, press **[Setting]**.

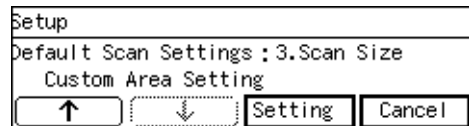

The setting screen for “ Custom Area Setting ” appears.

- 2 Use the [▶] and [◀] keys to highlight the item you want to input, and then use the number keys to input the value.

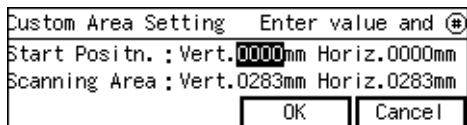

Note

- To correct the number you have entered, use the [▶] and [◀] keys to highlight it, and then press the [Clear/Stop] key to clear the number.
- You can also use the [#] key as well as the [▶] and [◀] keys to move selection.

- 3 Press [OK].

This saves the setting you have entered, and returns to the Default Scan Settings menu.

Note

- Pressing [Cancel] discards the values you have entered, and returns to the Default Scan Settings menu.

- 13 Press [Next].

“4. Image Density” appears as the setup item currently selected.

- 14 Press [OK].

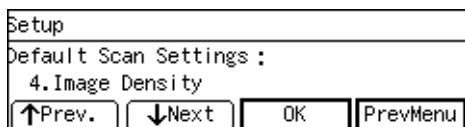

The setting screen for “4. Image Density” appears.

- 15 Use the [▶] and [◀] keys to highlight the setting you want.

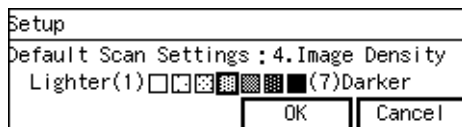

- 16 Press [OK].

This saves the setting you have selected, and returns to the Default Scan Settings menu.

Note

- Pressing [Cancel] discards the selected setting, and returns to the Default Scan Settings menu.

- 17 By pressing [Next] to display “5. Erase Colour” through “11. Original Settings” as the setup item, select options for each of them in the same way that you have done in steps 4 through 7.

- 18 After all the settings are the way you want, press [PrevMenu].

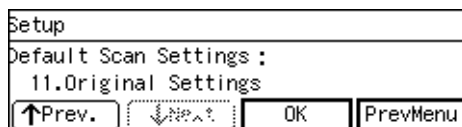

This registers the Scan Settings you have configured to the “Default” memory area, and returns to the Scan Settings menu.

- 19 While the Scan Settings menu is displayed, press [2], [3] or [4] key to display a corresponding User Scan Settings menu.

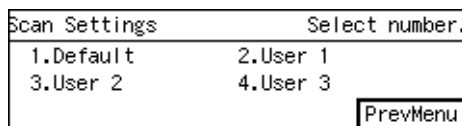

For example, press the [2] key to display the User 1 Scan Settings menu.

20 Repeat steps **4** through **18** for each of “ User 1”, “ User 2”, and “ User 3” memory areas.

21 When you are finished, press [PrevMenu].

This returns to the Scanner Features menu.

22 Press [Exit].

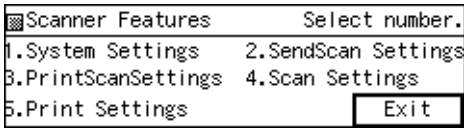

This exits the Scanner Features menu, and returns to the standby screen that is displayed when you turn the power on.

Important

Never turn off the power of this machine before the standby screen is displayed. Doing so can discard all the settings you have configured, and return this machine to its factory default status.

Note

Instead of pressing [Exit], you can press a number key to enter another setting menu.

Registering Print Settings

You can configure and register up to four sets of settings for printing scan data. Memory areas named " Default ", " User 1 ", " User 2 ", and " User 3 " are available for registering Print Settings. You can easily recall the settings you have registered to " User 1 ", " User 2 ", or " User 3 ", which means you don't have to configure detailed settings each time you print scan data. Settings registered to " Default " apply when you print scan data without selecting " User 1 ", " User 2 ", or " User 3 ", or without manually configuring Print Settings.

Information to Register in [Print Settings]

❖ Scan Type

This item lets you specify the type of originals (text or photo) for black and white or gray scale scanning.

Note

The following options do not apply when you configure settings to perform scan with full colour.

- Text
Select this option for standard originals containing mainly text. With this option, scan is performed with black and white (halftoning is done by error diffusion).
- Text/Photo
Select this option for originals containing a mixture of text and photographs. By selecting this option, scan is performed with gray scale.















- Photo
Select this option for originals containing photographs and/or other pictures. By selecting option, scan is performed with gray scale.

❖ Image Density

Use this item to adjust density of the image for scanning. You can select one of seven steps from 1 (lightest) to 7 (darkest).

❖ Original Size



Use this item to select the size of the originals to be scanned. You can select from the following options.







Auto Detect, A3 , A4 , A4 , A5 , A5 , 11x17 , 8¹/₂x14 , 8¹/₂x13 , 8¹/₂x11 , 8¹/₂x11 , 5¹/₂x8¹/₂ , 5¹/₂x8¹/₂ , B4JIS , B5JIS , B5JIS , Custom size

- The original sizes available for the **[Auto Detect]** function change depending on where you place the originals (on the exposure glass or on the ADF). See p.110 "The Original Sizes Available for Auto Detection" for details.
- When you select **[Custom Size]**, you can specify the dimensions of the scan area (width and height).

❖ Duplex

Use this item to select a type of duplex prints.

-  →  (1 Sided Orig. → 1 Sided Print)
Scans a single-sided original and prints onto a single-sided page.

-  →  (1 Sided Orig. → 2 Sided Print)
Scans two single-sided originals and prints onto a two-sided page.
-  →  (2 Sided Orig. → 1 Sided Print)
Scans each side of a two-sided original and prints onto two separate pages.
-  →  (2 Sided Orig. → 2 Sided Print)
Scans a two-sided original and prints onto a two-sided page.

❖ Reduce/Enlarge

This item lets you print scan data with the image reduced or enlarged using a preset ratio, or even changing the reproduction ratio in 1% increments.

- 25%
- 50%: A3 → A5, B4 → B6
- 61%: A3 → B5, A4 → B6
- 82%: B4 → A4, B5 → A5
- 87%: A3 → B4, A4 → B5
- 100%:
- 115%: B3 → A3, B5 → A4
- 122%: A4 → B4, A5 → B5
- 141%: A4 → A3, A5 → A4
- 200%: A5 → A3, B6 → B4
- 400%
- Custom Ratio: By selecting this option, you can change the reproduction ratio in 1% increments within the range of 25% to 400%.

Note

- This setup item appears as "Zoom" on the Web Status Monitor.

❖ Create Margin

Use this item to reduce the image to 93% of the original size.

Note

- This setup item is included under **[Reduce/Enlarge]** on the Web Status Monitor.
- When **[Create Margin]** is set to "On", the image is reduced to 93%, regardless of the settings in **[Reduce/Enlarge]**.

❖ Quality/Speed

Use this item to select scanning resolution.

- Quality
Scanning is performed in 600 dpi.
- Speed
Scanning is performed in 300 dpi.

Note

- This setup item does not affect printing resolution. The resolution for printing is determined by the printer's maximum resolution.

Registering [Print Settings]

Follow the steps below to configure and register Print Settings using the control panel of this machine.

Note

- You can also configure these settings using the Web Status Monitor.

Reference

See p.15 "Using Keys Displayed on the Screen" for information about how to select items displayed on the screen.

1 Press the **[User Tools]** key.

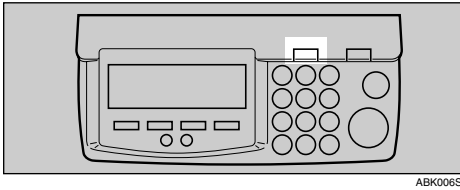

The Scanner Features menu is displayed.

2 Press the **[5]** key.

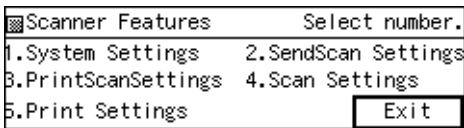

The Print Settings menu is displayed.

On this menu, you can select a memory area (" Default ", " User 1", " User 2", or " User 3") for registering the Print Settings configuration.

3 Press the **[1]** key.

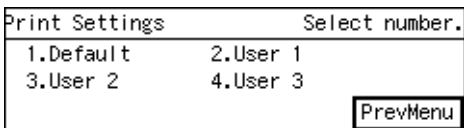

The Default Print Settings menu is displayed, and "1. Scan Type " appears as the setup item currently selected.

Note

Pressing **[PrevMenu]** returns to the parent menu screen.

4 Press **[OK]**.



The setting screen for "1. Scan Type " appears.

5 Select the scan type.



- The option that is currently selected is displayed first.
- "*" mark appears along with the option currently selected.
- Use **[↑]** and **[↓]** to display the option you want to select.

6 While the option you want to select is displayed, press **[OK]**.

This saves the setting you have selected, and returns to the Default Print Settings menu.

Note

Pressing **[Cancel]** discards the selected option, and returns to the Default Print Settings menu.

7 Press **[Next]**.

"2. Image Density " appears as the setup item currently selected.

Note

Pressing **[Prev.]** displays the previous setup item.

8 Press **[OK]**.

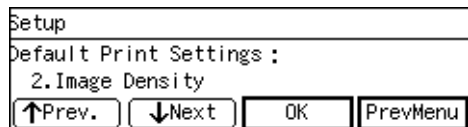

The setting screen for "2. Image Density " appears.

9 Use the **[▶]** and **[◀]** keys to highlight the setting you want.

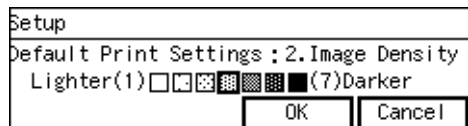

3

10 Press [OK].

This saves the setting you have selected, and returns to the Default Print Settings menu.

Note

- ❑ Pressing [Cancel] discards the selected setting, and returns to the Default Print Settings menu.

11 Press [Next].

"3. Original Size " appears as the setup item currently selected.

12 Press [OK].

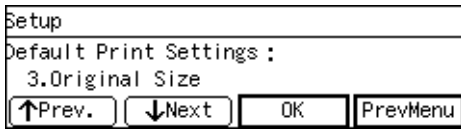

The setting screen for "3. Original Size " appears.

13 Select the original size.

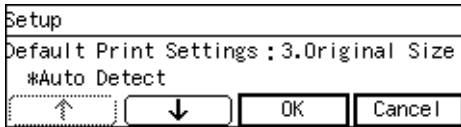

- The option that is currently selected is displayed first.
- "*" mark appears along with the option currently selected.
- Use [↑] and [↓] to display the option you want to select.

To select an original size from preset sizes

1 While the preset original size you want to select is displayed, press [OK].

This saves the setting you have selected, and returns to the Default Print Settings menu.

Note

- ❑ Pressing [Cancel] discards the selected option, and returns to the Default Print Settings menu.

To set a custom size

1 While the option " Custom Size " is displayed, press [Setting].



The setting screen for " Custom Size " appears.

2 Use the [▶] and [◀] keys to highlight the item you want to input, and then use the number keys to input the value.

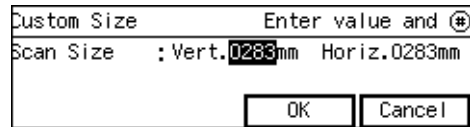

Note

- ❑ To correct the number you have entered, use the [▶] and [◀] keys to highlight it, and then press the [Clear/Stop] key to clear the number.
- ❑ You can also use the [#] key as well as the [▶] and [◀] keys to move selection.

3 Press [OK].

This saves the setting you have entered, and returns to the Default Print Settings menu.

Note

- ❑ Pressing [Cancel] discards the values you have entered, and returns to the Default Print Settings menu.

14 Press [Next], and then select an option for "4. Duplex " in the same way that you have done in the steps **4** through **6**.

15 Press [Next], and then select an option for "5. Reduce/Enlarge " in the same way that you have done in the steps **12** through **13**.

 **Note**

When you select the " Custom Ratio " option, use the number keys or [-] / [+] to enter the value.

16 By pressing [Next] to display "6. Create Margin " and "7. Quality/Speed " as the setup item, select options for each of them in the same way that you have done in steps **4** through **6**.

17 After all the settings are the way you want, press [PrevMenu].

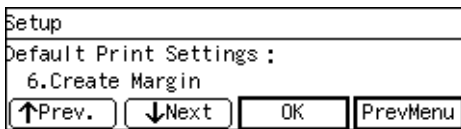

This registers the print settings you have configured to the "Default" memory area, and returns to the Print Settings menu.

18 While the Print Settings menu is displayed, press **[2]**, **[3]** or **[4]** key to display a corresponding User Print Settings menu.

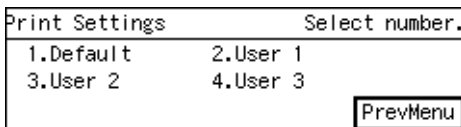

For example, press the **[2]** key to display the User 1 Print Settings menu.

19 Repeat steps **4** through **17** for each of " User 1", " User 2", and " User 3" memory areas.

20 When you are finished, press [PrevMenu].

This returns to the Scanner Features menu.

21 Press [Exit].

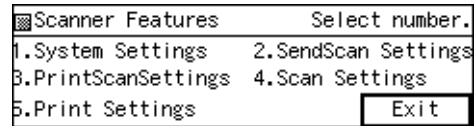

This exits the Scanner Features menu, and returns to the standby screen that is displayed when you turn the power on.

 **Important**

Never turn off the power of this machine before the standby screen is displayed. Doing so can discard all the settings you have configured, and return this machine to its factory default status.

Configuring Settings Using a Web Browser

This section describes the procedure to make various settings using a web browser on a client computer.

Important

- Before making any settings, connect this machine to the network and specify its IP address. p.55 “Configuring [System Settings]”
- To confirm the IP address of this machine that you have specified, press the **[User Tools]** key, press the **[1]** key to select **[1.System Settings]**, select **[2.IP Address]**, and then press **[OK]**. When you are finished, press **[Cancel]**, and then press the **[User Tools]** key to return to a standby screen.

Accessing the Scanner

System requirements of a client computer

❖ OS

- Microsoft Windows 95/98/98 SE/Me/2000 XP
- Microsoft Windows Server 2003
- Microsoft Windows NT4.0

❖ Web browser

- Microsoft Internet Explorer 4.0, 5.0, 5.5, 6.0

When you use a proxy server, set the web browser not to use the proxy server when accessing this machine.

When using Internet Explorer, you can make this setting by selecting **[Internet Options]** on the **[Tools]** menu, click **[LAN Settings]** on the **[Connections]** tab, and then select the **[Bypass proxy server for local addresses]** check box in the **[Proxy Server]** area. The setting can also be configured by entering the IP address of this machine to **[Exceptions]** box on the dialog box that appears when you click **[Advanced]** in the **[Proxy Server]** area.

To access this machine from a web browser

- 1 Start up a web browser on a client computer.
- 2 Input “http://xxx.xxx.xxx.xxx/” (“xxx.xxx.xxx.xxx” is the IP address for this machine) in the web browser’s address bar, and then press the [Enter] key.
The top page of the “Web Status Monitor” is displayed on the web browser, which means that you succeed in accessing to this machine.

**Note**

- The Web Status Monitor is embedded to this machine, so it is not necessary to install it to a client computer. You can use the Web Status Monitor to make settings or administrating the status of this machine.

General guide to the Web Status Monitor

The figure below shows a screen of the Web Status Monitor when the following menus are selected: **[Configuration]** main menu → **[Basic Settings]** sub-menu → **[Scanner]** sub-menu.



ADG011S

1. Header Area

Contains links to the top page and the on-line help of the Web Status Monitor.

2. Main Menu Area

Contains main menu items such as **[Status]**, **[Config Reference]** and **[Configuration]**. Clicking a main menu item refreshes the sub-menu area, displaying sub-menu items that are included under the main menu item.

3. Sub-Menu Area

Displays sub-menu items in accordance with the main menu item currently selected. Clicking a sub-menu item displays the contents of the item in the work area.

4. Scroll bar for the Sub-Menu Area

Use this scroll bar to scroll through the sub-menu area, when the lower or upper part of its content is out of sight.

5. Work Area

Displays contents such as setup items, options, and status information, in accordance with the sub-menu item currently selected.

Important

- It may not be possible to return to the previous page using the browser's **[Back]** button. In such a case, click the **[Update]** button on the browser. If a main menu or a sub-menu is clicked again, the information you input will be cleared.
- Depending on the font size setting, the contents may not be displayed properly. It is recommended to set the font size to "medium" or smaller.

6. Scroll bars for the Work Area

Use these scroll bars to scroll through the work area, when the lower/upper or rightmost/leftmost part of its content is out of sight.

Example Procedures Using [Configuration] Main Menu

This section gives you a few example procedures, to make settings of this machine using the Web Status Monitor.

Configuring [Scan Settings]

- 1** Click **[Configuration]** on the main menu.

The password input dialog box appears.

Note

- Once you set the password, the password input dialog box will not appear from the second time. When the dialog doesn't appear, proceed to **4**.

- 2** Input "scanner" for the user name, and input the password.

Note

- The user name is fixed to "scanner".
- The password is set to "password" as the factory default. You can change the password using **[Configuration]** → **[Basic Settings]** → **[Scan Settings]**.

- 3** Click **[OK]**.

The setup screen appears.

- 4** Click **[Basic Settings]**, and then **[Scan Settings]** in the sub-menu area.

- 5** Click **[Default]** in the **[Select User]** area.

- 6** Make settings to each of the setup items on the screen.

Note

- Register the scanning conditions that are most frequently used in **[Default]**. If scanning conditions are not specified for a send scan operation, the conditions set to **[Default]** applies.

- 7** Click **[OK]**.

Note

- Be sure to click **[OK]** to save the settings you have made on the currently displayed screen. Once you move to another page without clicking **[OK]**, all the settings that you have made on the previous page will be cleared.

- The changes are be discarded if you click **[Cancel]**.

8 By selecting **[User 1]**, **[User 2]**, or **[User 3]** in the **[Select User]** area, repeat steps **6** and **7** for each of them, as necessary.

Configuring [E-mail Address]

1 Click **[Configuration]** on the main menu.

The password input dialog box appears.

 **Note**

- Once you set the password, the password input dialog box will not appear from the second time. When the dialog doesn't appear, proceed to **4**

2 Enter "scanner" for the user name, and enter password.

 **Note**

- The user name is fixed to "scanner".
- The password is set to "password" as the factory default. You can change the password using **[Configuration]** → **[Basic Settings]** → **[Password]**.

3 Click **[OK]**.

Settings screen appears.

4 Click **[E-mail Settings]**, and then **[E-mail Address]** in the sub-menu area.

5 Follow the steps below to register an e-mail address, change or delete an existing e-mail address, export address data to a CSV file, or import address data from a CSV file.

To register an e-mail address

1 Click **[Add]**.

2 Make entry to or select an option for each of the setup items on the screen.

3 Click **[OK]**.

 **Note**

- Be sure to click **[OK]** to save the settings you have made on the currently displayed screen. Once you move to another page without clicking **[OK]**, all the settings that you have made on the previous page will be cleared.
- Input information is cleared when you click **[Cancel]**.

To change an existing e-mail address

1 Display the item that you want to change within the list on the screen.

 **Note**

- You can select the number of items to be displayed at a time by selecting a number in the **[Display Items]** box.
- Click **[Next]** or **[Prev]** to display the next or previous page. Click **[Top]** or **[End]** to display the first or last page.
- If you want to display a specific page, enter the page number in the **[Page(s)]** box, and then press **[Go]**.

2 Select the item that you want to change, by clicking the option button to the left of the item.

3 Click **[Change]**.

4 Make necessary changes.

5 Click **[OK]**.

 **Note**

- Be sure to click **[OK]** to save the settings you have made on the currently displayed screen. Once you move to another page without clicking **[OK]**, all the settings that you have made on the previous page will be cleared.
- The changes are discarded if **[Cancel]** is clicked.

To delete an existing e-mail address

- 1** Display the item that you want to delete within the list on the screen.

 **Note**

- You can select the number of items to be displayed at a time by selecting a number in the **[Display Items]** box.
 - Click **[Next]** or **[Prev]** to display the next or previous page. Click **[Top]** or **[End]** to display the first or last page.
 - If you want to display a specific page, enter the page number in the **[Page(s)]** box, and then press **[Go]**.
- 2** Select the item that you want to delete, by clicking the option button to the left of the item.
 - 3** Click **[Delete]**.
 - 4** On the confirmation dialog box that appears, click **[OK]** to delete the item.

To export the address data to a CSV file

- 1** Click **[Export]**.

The **[Export Data]** page appears.

- 2** Click the **[Download]** button to the right of **[Entered Program Information]**.
- 3** On the dialog box that appear, select **[Save this file to disk]**, and then click **[OK]**.

 **Note**

- The above dialog box varies depending on the version of the operating system (Windows). When a save dialog box appears here, click **[Save]** here.

The **[Save As]** dialog box appears.

- 4** Specify a file name and the location to save the file, and then click **[Save]**.

 **Note**

- The default name that is automatically assigned to the file is "<device name_addr.csv". For "<device name", the name that is specified for the machine's device name is used. (You can specify the device name using **[Configuration]** → **[Basic Settings]** → **[General Settings]** → **[Device Name]**.)

This returns to the **[Export Data]** page.

 **Note**

- When the **[Close this dialog when download completes]** check box is not selected on the dialog box that appears when you click **[Save]**, the dialog box remains displayed after download is finished. In this case, press **[Close]** to close the dialog box and return to the **[Export Data]** page.

5 If you want to export title information (device tag information), click the **[Download]** button to the right of **[Device Tag Information]**.

6 Repeat steps **3** and **4** to save the device tag information.

 **Note**

- The default name that is automatically assigned to the file is "<device name>_taginfo.csv". For "<device name>", the name that is specified for the machine's device name is used. (You can specify the device name using **[Configuration]** → **[Basic Settings]** → **[General Settings]** → **[Device Name]**.)

To import the address data from a CSV file

 **Limitation**

- If you perform the following procedures, the current address data is overwritten with the address data that you import. Before importing the address data, be sure to export the current address data for a backup.

 **Note**

- It is good idea to start with the CSV file that is exported using the Web Status Monitor. You can use the file exported using **[Entered Program Information]** for adding, changing or deleting the address data. It becomes much easier to update the address book information by importing the edited file. See the Web Status Monitor Help for more information.

 **Reference**

For information about the file format of the CSV file, see p.191 "E-mail Address Book Data Format and Device Tag Information"

1 Prepare a CSV file that you want to use for importing the address data, and save it on a local disk or in a shared folder on your network.

2 Click **[Import]**.

The **[Import Data]** page appears.

3 Click **[Browse]**, select the CSV file that you have prepared, and then click **[Open]**.

4 On the **[Import Data]** page, click **[OK]**.

A confirmation dialog box for a batch registration of the address book appears.

5 Click **[OK]**.

When the import operation is finished, the message "Programmed Address Book as a batch. Click **[Back]** to continue." appears.

6 Click **[Back]** on the web browser.

 **Note**

- To return to the E-mail Address screen, click **[Back]** again, or click **[E-mail Address]** in the sub-menu area.

6 If “ Off ” is selected for **[Auto Update Destination List]** in **[2.Send Scan Settings]** on this machine, restart this machine to reflect additions and changes made to the destination list.

 **Note**

- If “ On ” is selected for **[Auto Update Destination List]**, the destination list is automatically updated when you press **[OK]** in step **5** above. You can instantly use the updated destination list by pressing **[Dest.]** or **[Sender]** on the control panel of this machine. See p.61 “Auto Update Destination List” for details.

Information to Register as Destination and Printer

You can register **[E-mail Address]**, **[File Send Path]** and **[FTP Server]** as destinations for sending scan data. This section describes the setup items included in these sub-menus.

This section also explains the setup items that are included in **[Printer]**, which determines a printer for Print Scan output.

See the Web Status Monitor Help for information about setup items that are not described here.

Information to register in **[E-mail Address]**

You can register destination addresses to which you use for sending scanned data as an e-mail attachment. Up to 2000 e-mail addresses can be registered.

❖ **Program No.**

Enter a number for the e-mail address between 00001 and 50000. You cannot enter a number already used.

 **Note**

- The first unused number is displayed as the default.

❖ **Name(s)**

The name specified here is used for recognizing each of the registered destinations (or senders) on the Web Status Monitor. Register a name within 20 characters.

❖ **Key Display**

The key display is used for selecting a destination (or sender) on the control panel of this machine. Register a key display name within 16 characters. The first 16 characters of the name that you have registered to **[Name(s)]** are automatically used if you skip registering a key display name.

❖ **Assign Title**

You can assign an item under the following three types of titles for recalling the destination’s (or sender’s) key display name quickly on the control panel of this machine.

- Alphabet
[ABC], [DEF], [GHI], [JKL], [MNO], [PQRS], [TUV], [WXYZ]
- Custom Title
[1], [2], [3], [4], [5]

- Frequently Used Title(s)
Select “ On ” if you want the item to be included in the [Freq.] page, which is displayed as the first title for both the alphabetical and custom title lists. Select “ Off ” if you do not want the item in the [Freq.] page.

Important

- Before assigning a custom title, it is necessary to register custom titles using the Web Status Monitor, and restart this machine. You cannot configure [E-mail Address] and [Custom Title] settings at the same time.

Note

- Under each of the titles, the assigned items are listed by the order of registration.

❖ E-mail

- E-mail Address
Enter the e-mail address used as the destination.
- Register as Sender
Select whether to use the e-mail address not only as the destination but as the sender also.
- Sender's Password
Select whether to set a password for the e-mail address. When [On] is selected, a password is required when this e-mail address is specified as the destination.
- Protected Password and Confirm Protected Password
Enter the password when [On] is selected for [Sender's Password], using four to eight digits. Each password digit appears as "*" .

Information to register in [File Send Path]

You can register a path for sending scanned data to a shared folder using SMB. Up to 1000 destination folders can be registered.

Reference

See the Web Status Monitor Help for information about how to register a File Send Path.

❖ Program No.

Enter a number for the destination folder between 00001 and 50000. You cannot enter a number already used.

Note

- The first unused program number is displayed as the default.

❖ File Send Path Name

Enter a name for identifying the destination folder, using up to 80 characters.

❖ Key Display

Enter the name to appear on the control panel of this machine, using up to 16 characters. The first 16 characters of the file send path name are automatically used if you skip registering a key display name.

❖ Assign Title

You can assign a file send path record under the following three types of titles for recalling the key display name quickly on the control panel of this machine.

- Alphabet
[ABC], [DEF], [GHI], [JKL], [MNO], [PQRS], [TUV], [WXYZ]
- Custom Title
[1], [2], [3], [4], [5]

- Frequently Used Title(s)
Select " On " if you want the file send path record to be included in the **[Freq.]** page, which is displayed as the first title for both the alphabetical and custom title lists. Select " Off " if you do not want the item in the **[Freq.]** page.

Important

- Before assigning a custom title, it is necessary to register custom titles using the Web Status Monitor, and restart this machine. You cannot configure **[File Send Path]** and **[Custom Title]** settings at the same time.

Note

- Under each of the records, the assigned items are listed by the order of registration.

◆ File Send

- File Send Path
Enter the path to the destination in the format of "\\host name\folder name" or "\\IP address\folder name".

Note

- Be sure to specify folders that are on the root directory of a host computer. You cannot specify any sub-directories for "folder name" in the above syntax.
- Login User Name
Enter a user name with shared folder access, in the format of "work group name\user name" or "domain name\user name".

Note

- When the shared folder you register is on a file server, enter a user name available for logging in to the file server.

- When the shared folder you register is configured an access right by Windows 2000/XP, Windows Server 2003, or Windows NT4.0, enter the user name that is specified as the administrator of the operating system. 1

- When the shared folder you register is on a client computer, enter a user name available for logging in to the network.

- Login Password and Confirm Login Password
Enter the password for the user name displayed in the **[Login User Name]** box. Each password character appears as "*".

Note

- When accessing a shared folder that is password protected under Windows 95/98/98 SE/Me, enter the password.

- **[Test]**
Click this button to confirm the availability of the entries to the **[File Send Path]**, **[Login User Name]**, and **[Login Password]** boxes.

- Sender's Password
Select whether to set a password for the destination folder. When **[On]** is selected, a password is required when this folder is specified as the destination.

- Protected Password and Confirm Protected Password
Enter the password when **[On]** is selected for **[Sender's Password]**, using four to eight digits. Each password digit appears as "*".

❖ **Change Order**

This item is displayed only when you perform **[Change]** in “ File Send Path ” operation. Normally, the File Send Paths you registered using **[Add]** in “ File Send Path ” are displayed by the order of registration. If you want to change the order of a registered File Send Path, select “ On ” for **[Change Order]**, and then enter the number of the new order (that applies when you select “ All ” in a title list screen of the machine) into **[Change Order]** box.

 **Note**

- If you enter “5” into **[Move to]** box and perform **[Change Order]** operation for the File Send Path that is currently displayed in the 15th place when you select “ All ” in a title list screen of the machine, the File Send Path moves to the 5th place. At this time, the File Send Paths that are formerly displayed in the 5th through 14th places move to the 6th through 15th places, respectively.

Information to register in [FTP Server]

You can register an FTP server address for sending scanned data to a shared folder on the FTP server. Up to 1000 FTP server addresses can be registered.

 **Reference**

See the Web Status Monitor Help for information about how to register an FTP Server address.

❖ **Program No.**

Enter a number for the FTP server address between 00001 and 50000. You cannot enter a number already used.

 **Note**

- The first unused program number is displayed as the default.

❖ **FTP Server Name**

Enter a name for identifying the FTP server address, using up to 80 characters.

❖ **Key Display**

Enter the name to appear on the control panel, using up to 16 characters. The first 16 characters of the FTP server name are automatically used if you skip registering a key display name.

❖ **Assign Title**

You can assign an FTP server record under the following three types of titles for recalling the key display name quickly on the control panel of this machine.

- Alphabet
[ABC], [DEF], [GHI], [JKL], [MNO], [PQRS], [TUV], [WXYZ]
- Custom Title
[1], [2], [3], [4], [5]
- Frequently Used Title(s)
Select “ On ” if you want the FTP server record to be included in the **[Freq.]** page, which is displayed as the first title for both the alphabetical and custom title lists. Select “ Off ” if you do not want the item in the **[Freq.]** page.

 **Important**

- Before assigning a custom title, it is necessary to register custom titles using the Web Status Monitor, and restart this machine. You cannot configure **[FTP Server]** and **[Custom Title]** settings at the same time.

 **Note**

- Under each of the records, the assigned items are listed by the order of registration.

❖ FTP Server

- **Server Name/Path Name**
Enter the path to the FTP server shared folder, in the format of "server name\folder name" or "IP address\folder name".

 **Note**

- Be sure to specify folders that are on the root directory of an FTP server. You cannot specify any sub-directories for "folder name" in the above syntax.

 **Note**

- When you connect to an FTP server using a specific port, enter the port number in decimal followed by ":" after server name (or IP address). If you do not specify a port number, the default port number (21) is automatically applies.
- **Login User Name**
Enter a user name with shared folder access.

 **Note**

- A login user name is registered using up to 20 characters on the Web Status Monitor. Specify login user names within 20 characters on the FTP server, to which you want to send scanned files from this machine.

- **Login Password and Confirm Login Password**
Enter the password for the user name displayed in the **[Login User Name]** box.

 **Note**

- A login password is registered using up to 14 characters on the Web Status Monitor. Specify login password within 14 characters on the FTP server, to which you want to send scanned files from this machine.

- **[Test]**
Click this button to confirm the availability of the entries to the **[Server Name/Path Name]**, **[Login User Name]**, and **[Login Password]** boxes.
- **PASV Mode Configuration**
Select whether to use the PASV mode to send a file. The default is **[Off]**. If you can log on to the specified FTP server but cannot send a file, select **[On]**.

 **Note**

- This machine does not support connection to an FTP server via a proxy server.
- **Sender's Password**
Select whether to set a password for the FTP server address. When **[On]** is selected, a password is required when this FTP server address is specified as the destination.
- **Protected Password and Confirm Protected Password**
Enter the password when **[On]** is selected for **[Sender's Password]**, using four to eight digits. Each password digit appears as "*".

Information to register in [Printer]

You can register up to 99 printers including local printers.

Note

- You cannot select a paper tray to supply paper when performing a Print Scan operation. To select a certain paper tray for Print Scan, it is necessary to register each of paper trays of a printer as an independent printer, by using **[Configuration]** → **[Print Scan Settings]** → **[Printer]** on the Web Status Monitor.

Reference

See the Web Status Monitor Help for information about how to register a printer.

❖ Program No.

Assign a program number to each of printer registrations within the range of 01 through 99. The smallest unused program number is automatically assigned when you register a new printer. You can also change the program number manually.

❖ Printer Name

[Printer Name] is used for recognizing each of the registered printers on the Web Status Monitor when monitoring printout jobs. Enter a printer name within 80 characters.

❖ Key Display

Enter the name to appear on the control panel, using up to 16 characters. The first 16 characters of the printer name are automatically used if you skip registering a key display name.

Important

- If you enter nothing into the **[Key Display]** box (by clearing the characters that are automatically entered) and then press **[OK]**, the message "This parameter does not have any changes" appears. Never leave the **[Key Display]** box empty.

❖ Assign Title

You can assign a printer under the following three types of titles for recalling the printer's key display name quickly on the control panel of this machine.

- Alphabet
[ABC], [DEF], [GHI], [JKL], [MNO], [PQRS], [TUV], [WXYZ]
- Custom Title
[1], [2], [3], [4], [5]
- Frequently Used Title(s)
Select " On " if you want the printer to be included in the **[Freq.]** page, which is displayed as the first title for both the alphabetical and custom title lists. Select " Off " if you do not want the printer in the **[Freq.]** page.

Important

- Before assigning a custom title, it is necessary to register custom titles using the Web Status Monitor, and restart this machine. You cannot configure **[Printer]** and **[Custom Title]** settings at the same time.

Note

- Under each of the titles, the assigned printers are listed by the order of registration.

◆ Attachment Type

Specify the type of connection method between the printer and this machine.

- Local Printer

Select this option when the printer is a local printer connected to this machine using a USB cable.

Note

- You cannot use more than one printer as a local printer at the same time. When you connect two or more printers to the machine using USB cables, the printer that is detected by this machine first is only available.
- Network Printer
Select this option when the printer is a network printer.

◆ Printer IP Address

When "Network Printer" is selected for **[Attachment Type]**, enter the IP address of the printer in the form of xxx.xxx.xxx.xxx (xxx:0 through 255).

Note

- You cannot configure this setting using a host name.
- Be sure to assign a fixed IP address even if you use the printer on a DHCP environment.

◆ [Obtain Printer Information]

Click to obtain paper tray information for the printer.

For a network printer, be sure to enter the correct IP address, and then click **[Obtain Printer Information]**.

An error message appears if the IP address entered is incorrect. Enter the correct IP address.

◆ Default Printer

Click **[Yes]** to set the printer as the default printer.

Only one printer can be set as the default printer at a time.

Note

- When only one printer is registered, that printer is set as the default automatically.
- If **[Yes]** is selected for this printer, the current default printer will no longer be the default.
- If the setting for the current default printer is changed to **[No]**, the error message appears. Set another printer as the default.

❖ **Locked Print**

Select **[On]** to print scanned images only after a password is entered on the printer control panel. This prevents other people from seeing the prints.

❖ **Paper Source Tray**

Select a paper tray.

Click **[Obtain Printer Information]** to update the list of available paper trays.

For a network printer, be sure to enter the IP address in the box of **[Attachment Type]** first, and then click **[Obtain Printer Information]**.

❖ **Change Order**

This item is displayed only when you perform **[Change]** in “Printer” operation. Normally, the printers you registered using **[Add]** in “Printer” are displayed by the order of registration. If you want to change the order of a registered printer, select “On” for **[Change Order]**, and then enter the number of the new order (that applies when you select “All” in a title list screen of the machine) into **[Move to]** box.

 **Note**

- If you enter “5” into **[Move to]** box and perform **[Change Order]** operation for the printer that is currently displayed in the 15th place when you select “All” in a title list screen of the machine, the printer moves to the 5th place. At this time, the printers that are formerly displayed in the 5th through 14th places move to the 6th through 15th places, respectively.

Recalling the Settings

You can recall the current settings of this machine for confirmation, by using the Web Status Monitor.

To recall the settings

- 1** Click **[Config Reference]** on the main menu.
- 2** Click the item that you want to recall in the sub-menu area.

Creating a Backup File of All the Settings

It is possible to store the settings such as scanning conditions as a file in a shared folder on the network. This file can be used to restore the settings in case they are lost. In addition, if you use two or more units of this scanner, it is possible to configure necessary settings on only one unit and copy the settings to other units.

Setup items to be backed-up and restored

You can create a backup file that contains all the settings included under the **[Configuration]** main menu (except **[Backup]** in the **[Basic Settings]** sub-menu), and the settings can be restored using the backup file.

Even the settings that are configured by using the control panel of this machine are backed up, as long as the settings are included under the **[Configuration]** main menu of the Web Status Monitor. Note, however, that there are setup items that can only be configured by using the control panel of this machine. These setup items are not included in the backup file.

Note

- You cannot specify the items to be backed up or restored separately.
- When you use a backup file to copy the settings to another unit, it is necessary to change the settings that must be unique for each of the units, such as an IP address setting.

To create a backup file

- 1** Click **[Configuration]** on the main menu.

The password input dialog box appears.

Note

- Once you set the password, the password input dialog box will not appear from the second time. When the dialog doesn't appear, proceed to **4**.

- 2** Enter "scanner" for the user name and enter the password.

Note

- The user name is fixed to "scanner".
- The password is set to "password" as the factory default. You can change the password using **[Configuration]** → **[Basic Settings]** → **[Password]**.

- 3** Click **[OK]**.

The setup screen appears.

- 4** Click **[Basic Settings]**, and then **[Backup]** in the sub-menu area.

5 Enter each of the items on the screen.

❖ **File Send Path**

Enter the shared folder path for storing the backup file. Enter the path in the format of "\\host name\folder name" or "\\IP address\folder name".

 **Note**

- The specified IP address is effective only for the computer running Windows 2000/XP or Windows NT as operating system. An IP address cannot be specified for a host running Windows 98/Me as operating system.

❖ **Login User Name**

Enter a user name with shared folder access, in the format of "work group name\user name" or "domain name\user name".

❖ **Login Password**

Enter the password for the user name displayed in the **[Login User Name]** box. Each password character appears as "*".

 **Note**

- If you are running Windows 98/Me and a shared folder password is required, enter it.

❖ **[Test]**

Click to check whether connection to the specified shared folder is enabled when data is entered in the **[File Send Path]**, **[Login User Name]**, and **[Login Password]** boxes.

❖ **Backup File Name**

Enter a file name for the backup file. Enter a name using up to 20 characters.

6 When everything is the way you want, click **[Backup]**.

 **Note**

- Click **[Cancel]** to restore the former settings on the screen.

After a backup file is created, the message "Backup has succeeded." appears.

7 Confirm that the backup file is created in the folder you have specified, by using the Windows explorer.

To restore settings from a backup file

1 Click **[Configuration]** on the main menu.

The password input dialog box appears.

 **Note**

- Once you set the password, the password input dialog box will not appear from the second time. When the dialog doesn't appear, proceed to **4**.

2 You can change the password using **[Configuration]** → **[Basic Settings]** → **[Password]**.

 **Note**

- The user name is fixed to "scanner".
- The password is set to "password" as the factory default. You can change the password using **[Configuration]** — **[Basic Settings]** — **[Password]**.

3 Click **[OK]**.

The setup screen appears.

4 Click **[Basic Settings]**, and then **[Backup]** in the sub-menu area.

5 Enter each of the items on the screen.

❖ **File Send Path**

Enter the path to the shared folder where the backup file is stored. Enter the path in the format of "\\host name\folder name" or "\\IP address\folder name".

 **Note**

- The specified IP address is effective only for the computer running Windows 2000/XP or Windows NT as operating system. An IP address cannot be specified for a host running Windows 98/Me as operating system.

❖ **Login User Name**

Enter a user name with shared folder access, in the format of "work group name\user name" or "domain name\user name".

❖ **Login Password**

Enter the password for the user name displayed in the **[Login User Name]** box.
Each password character appears as "*".

 **Note**

- If you are running Windows 98/Me and a shared folder password is required, enter it.

❖ **[Test]**

Click to check whether connection to the specified shared folder is enabled when data is entered in the **[File Send Path]**, **[Login User Name]**, and **[Login Password]** boxes.

❖ **Backup File Name**

Enter the backup file name from which you want to restore the settings. Enter a name using up to 20 characters.

6 When everything is the way you want, click **[Restore]**.

 **Note**

- Click **[Cancel]** to restore the former settings on the screen.

After a restore operation is complete, the message "Restore has succeeded" appears.

7 Turn off the power of this machine, and then back on.

This applies the settings that are restored from the backup file to this machine.

Installing Software

To use this machine as a network TWAIN scanner, it is necessary that the network TWAIN driver is installed on the computer from which you use this machine.

To use the machine as a network delivery scanner, it is essential to install ScanRouter V2 Lite on the delivery server. To check an in-tray or retrieve file, it is necessary to install DeskTopBinder V2 Lite on the client computer.

3

List of Files

CD-ROM Drive	Wizard for the TWAIN driver and utilities		
	DRIVERS	TWAIN	TWAIN driver for Windows 95/98/Me, Windows XP, Windows 2000, Windows NT 4.0
	UTILITY	DESKLT	Desk Top Binder V2 Lite
		ROUTE RV2	Scan Router V2 Lite
85	DEV-MON	SmartDeviceMonitor for Admin, SmartDeviceMonitor for Client	

Auto Run Program

When the CD-ROM is inserted into a client computer in Windows 95/98/Me, Windows XP, Windows 2000, or Windows NT 4.0, the installer starts automatically (Auto Run) to install the TWAIN driver and various software.

 **Note**

- Auto Run might not automatically work with certain operating system settings. In this case, launch "Setup.exe" located in the CD-ROM root directory.
- If you want to install the software without using Auto Run, hold down the **[Shift]** key while inserting the CD-ROM. Keep the **[Shift]** key held down until the client computer has finished accessing the CD-ROM.
- If **[Cancel]** is pressed during installation, the installation will be stopped and all the remaining software will not be installed. If **[Cancel]** has been pressed, reinstall the remaining software after restarting the client computer.

 **Limitation**

- For installation in Windows 2000, Windows XP, or Windows NT 4.0, log in as a member of the administrators group.

Software for Using a Network TWAIN Scanner

To use the machine as a network TWAIN scanner, it is essential to install the TWAIN driver.

If you do not have applications that work with TWAIN, it is necessary to also install DeskTopBinder V2 Lite. For information about the installation of DeskTopBinder V2 Lite, see p.105 “DeskTopBinder V2 Lite”.

System requirements

Limitation

Under Windows NT with RISC-based processors (MIPS R series, Alpha AXP, or PowerPC), this driver is not available.

- Hardware
PC/AT compatible
- CPU
Pentium or faster (Pentium 150 MHz or faster recommended)
- Operating system
Microsoft Windows 95 (OSR 2 or later)
Microsoft Windows 98
Microsoft Windows Millennium Edition (Windows Me)
Microsoft Windows 2000 Professional
Microsoft Windows 2000 Server
Microsoft Windows XP Home Edition
Microsoft Windows XP Professional
Microsoft Windows NT Workstation 4.0 (Service Pack 5 or later)
Microsoft Windows NT Server 4.0 (Service Pack 5 or later)
- Memory
Operating system min. operation memory + 8 MB (64 MB or more recommended)
- Hard disk space
100 MB or more
- Display resolution
800 × 600 pixels, 256 colours or higher

- Network protocol
TCP/IP

Using Windows 95/98/Me, Windows XP, Windows 2000, or Windows NT 4.0

Install the TWAIN driver using Auto Run.

1 Start Windows, and then insert the supplied CD-ROM labeled “Scanner Driver & Document Management Utilities” into the CD-ROM drive of the client computer.

The CD-ROM Launcher screen appears.

Reference

If the installer does not start automatically, see p.102 “Auto Run Program”.

2 Click [TWAIN Driver].

The Software Setup screen appears.

3 The installer of the TWAIN driver starts. Follow the instructions on the screen.

Note

When the installation is complete, a message to prompt you to restart the client computer may appear. In this case, restart the client computer.

- ❑ After the installation is complete, the “Type 2232C_2238C TWAIN V3” folder is in the “Program” folder on the Start menu. Help can be displayed from here.
- ❑ Notes on using the network TWAIN scanner are provided in “Readme.txt”. Be sure to read them before use.

Software for Using the Network Delivery Scanner Function

Use Auto Run for installation.

3

System requirements

- Hardware
PC/AT compatible
- CPU
Pentium 133 MHz or faster (Pentium II 266 MHz or faster recommended)
- Operating system
Microsoft Windows 95 (OSR 2 or later)
Microsoft Windows 98
Microsoft Windows Millennium Edition (Windows Me)
Microsoft Windows 2000 Professional (Service Pack 1 or later)
Microsoft Windows 2000 Server (Service Pack 1 or later)
Microsoft Windows XP Home Edition
Microsoft Windows XP Professional
Microsoft Windows Server 2003 Standard Edition
Microsoft Windows Server 2003 Enterprise Edition
Microsoft Windows Server 2003 Web Edition
Microsoft Windows NT Workstation 4.0 (Service Pack 5 or later)
Microsoft Windows NT Server 4.0 (Service Pack 5 or later)
- Memory
48 MB or more (128 MB or more recommended)
- Hard disk space
50 MB or more (200 MB or more recommended)
- Display resolution
800 × 600 pixels, 64K colours or higher
- Network protocol
TCP/IP

1 Start Windows, and then insert the supplied CD-ROM labeled “Scanner Driver & Document Management Utilities” into the CD-ROM drive of the client computer.

The CD-ROM Launcher screen appears.

2 Click the key of the software to be installed.

- Click [**ScanRouter V2 Lite**], and then the ScanRouter V2 Lite Setup screen appears.

- Click [**DeskTopBinder V2 Lite**], and then the DeskTopBinder V2 Lite Setup screen appears.

3 Click [**ScanRouter V2 Lite**] or [**DeskTopBinder V2 Lite**]. The installer of the software starts. Follow the instructions on the screen.

Reference

For information about the subsequent installation procedure, see Setup Guide that can be displayed from the Setup screen of the respective software.

DeskTopBinder V2 Lite

Use Auto Run for installation.

System requirements

Limitation

- When installing the software in Windows NT Server or Windows 2000 Server, a stand-alone server must be used. Do not use the primary domain controller or backup domain controller.
- If you install this software in an operating system, such as Windows NT Workstation and Windows 2000 Professional, in which a client server is not permitted to be used in a network, you may violate the license agreement of Microsoft Corporation.
- Under Windows Server 2003, this software is not available.
 - Hardware
PC/AT compatible
 - CPU
Pentium 200 MHz or faster (Pentium II 350 MHz or faster recommended)
 - Operating system
Microsoft Windows 95 (OSR 2 or later)
Microsoft Windows 98
Microsoft Windows Millennium Edition
Microsoft Windows 2000 Professional (Service Pack 1 or later)
Microsoft Windows 2000 Server (Service Pack 1 or later)
Microsoft Windows XP Home Edition
Microsoft Windows XP Professional
Microsoft Windows NT Workstation 4.0 (Service Pack 5 or later)
Microsoft Windows NT Server 4.0 (Service Pack 5 or later)
 - Memory
64 MB or more (128 MB or more recommended)
 - Hard disk space
Minimum free space required for installing: 200 MB

 **Note**

In addition to the space required for installation, the hard disk should have at least 500 MB of free space for files.

- Network protocol
TCP/IP

1 Start Windows, and then insert the supplied CD-ROM labeled “Scanner Driver & Document Management Utilities” into the CD-ROM drive of the client computer.

The CD-ROM Launcher screen appears.

2 Click [DeskTopBinder V2 Lite].

The DeskTopBinder V2 Lite Setup screen appears.

3 Click [DeskTopBinder V2 Lite]. The Installer of the DeskTopBinder V2 Lite starts. Follow the instructions on the screen.

 **Reference**

For information about the subsequent installation procedure, see Setup Guide that can be displayed from the Setup screen of DeskTopBinder V2 Lite.

SmartDeviceMonitor

About SmartDeviceMonitor for Admin and SmartDeviceMonitor for Client

“ SmartDeviceMonitor for Admin ” is utility software for managing multiple scanners and printers on a network efficiently. Install this software on an administrator computer if necessary.

“ SmartDeviceMonitor for Client ” is utility software for the effective use of multiple scanners and printers on a network with IP addresses. Install this software on a client computer as necessary.

This software:	Manages:	Performs (related to scanners):	To be installed on:
SmartDeviceMonitor for Admin	Multiple scanners and printers on the network	<ul style="list-style-type: none"> • Changing the device name *1 • Changing the IP address *1 • Displaying status 	Network administrator’s computer
SmartDeviceMonitor for Client	Multiple scanners and printers on the network	<ul style="list-style-type: none"> • Displaying status 	Each of client computers
Web Status Monitor	This machine	<ul style="list-style-type: none"> • Making various settings (see p.41 “Initial Scanner Setup” 	--

- *1 You cannot use the Ethernet board setup tool included in the SmartDeviceMonitor for Admin when you access to this machine (it's not possible to change the device name and the IP address of this machine). You can change the device name and the IP address of other devices.

Installing SmartDeviceMonitor

Use Auto Run for installation.

- 1** Start Windows, and then insert the supplied CD-ROM labeled "Scanner Driver & Document Management Utilities" into the CD-ROM drive of the computer.

The CD-ROM Launcher screen appears.

- 2** Click the key of the software to be installed.

- Click [**SmartDeviceMonitor for Admin**], and then the SmartDeviceMonitor for Admin Setup screen appears.
- Click [**SmartDeviceMonitor for Client**], and then the SmartDeviceMonitor for Client Setup screen appears

- 3** Follow the instructions on the screen.



 **Note**

- After the installation is complete, the "SmartDeviceMonitor for Admin" or "SmartDeviceMonitor for Client" folder is in the "Program" folder on the Start menu. Help can be displayed from here.
- Notes on using the relevant software are provided in "Readme.txt". Be sure to read them before use.

4. Setting Originals

This chapter describes how to set an original to be scanned with this machine. It is possible to set an original on the exposure glass or the ADF. To scan several pages successively, the ADF is convenient.

Sizes and Weights of recommended Originals

Where original is set		Original size	Original weight
Exposure glass		Up to A3(297mm×420mm) Up to 11"×17"	—
ADF	One side	❖ Standard size Maximum : A3,  , 11"×17"  Minimum : A5" 	41-128g/m ²
	Both sides	❖ Non-standard size Maximum: 297 mm × 2000 mm (when scanning in binary), 297 mm × 630 mm (when scanning in colour or gray scale) Minimum: 105 mm × 128 mm	52-105g/m ²

Note

- To scan an original which size is A5 or smaller, or which weight is 52g/m² or lighter from the ADF using a network TWAIN driver, set **[Location]** to "ADF (thin paper)" on the application software you use the network TWAIN driver. For details, see the network TWAIN driver help.
- When you perform a Send Scan (e-mail, Send File (SMB/FTP) or Delivery Server) or a Print Scan operation using the ADF, set **[ADF Thin Paper]** to "On" if the originals to be scanned are 52g/m² (45kg) or thinner, or A5 size or smaller.

The Original Sizes Available for Auto Detection









The document sizes that are automatically detected by this machine are as follows

⚠ Limitation







- ❑ You can use auto detection for an ADF scanning, only when all the originals are the same, standard size.

❖ When set on the exposure glass

Europe/Asia

- A3  (297mm×420mm, 11"×16.5")
- B4  (257mm×364mm, 10.1"×14.3")
- A4  (210mm×297mm, 8.3"×11")
- A4  (297mm×210mm, 11"×8.3")
- B5  (182mm×257mm, 7.2"×10.1")
- B5  (257mm×182mm, 10.1"×7.2")
- 8.5"×13"  (F4)
- 8"×13"  (F) ^{*1}

North America









- 11"×17"  (DLT)
- 11"×15"  ^{*2}
- 10"×14" 
- 8.5"×14"  (LG)
- 8.5"×11"  (LT)
- 8.5"×11"  (LT)
- 10"×8" 

^{*1} Detected as F4 size.

^{*2} Detected as DLT size.

❖ When set in the ADF











Europe/Asia

- A3  (297mm×420mm, 11"×16.5")
- B4  (257mm×364mm, 10.1"×14.3")
- A4  (210mm×297mm, 8.3"×11")
- A4  (297mm×210mm, 11"×8.3")
- B5  (182mm×257mm, 7.2"×10.1")
- B5  (257mm×182mm, 10.1"×7.2")
- A5  (148mm×210mm, 5.8"×8.3")
- A5  (210mm×148mm, 8.3"×5.8")

8.5"×13"  (F4)

8"×13"  (F) ^{*1}

North America

- 11"×17"  (DLT)
- 11"×15"  ^{*2}
- 10"×14" 
- 8.5"×14"  (LG)
- 8"×13"  (F) ^{*3}
- 8.5"×11"  (LT)
- 8.5"×11"  (LT)
- 10"×8"  ^{*4}
- 5.5"×8.5"  (HLT)
- 5.5"×8.5"  (HLT)

^{*1} Detected as F4 size.

^{*2} Detected as DLT size.

^{*3} Detected as LG size.

^{*4} Detected as LT size.

Note

- ❑ In some cases, scanning in colour may not be available even when you use originals shown above. For details, refer to the network TWAIN driver help or Readme.txt on the CD-ROM.

Originals that Require Special Care

When scanning the following types of originals, be sure to follow the descriptions below.

❖ Originals whose size is difficult to auto detect

It is difficult for this machine to automatically detect the sizes of the following types of originals, so select the original size manually.

- Originals with indexes, tags, or other protrusions
- Transparent originals such as OHP transparencies or translucent paper
- Text or picture dense original
- Originals containing solid images
- Originals containing solid images around their edges

❖ Originals that cannot be set in the ADF

Placing the following types of originals in the ADF can cause paper misfeeds or result in damage to the originals. Place these originals on the exposure glass instead.

- Stapled or clipped originals
- Perforated or torn originals
- Curled, folded, or creased originals
- Pasted originals
- Originals with any kind of coating, such as thermal fax paper, art paper, aluminum foil, carbon paper, or conductive paper
- Originals with perforated lines
- Originals with indexes, tags, or other projecting parts
- Sticky originals such as translucent paper
- Thin originals that have low stiffness
- Thick originals such as postcards
- Bound originals such as books
- Transparent originals such as OHP transparencies or translucent paper
- Originals with ink or correction liquid on them and still not completely dry
- Originals that have curls such as shown in the illustration below

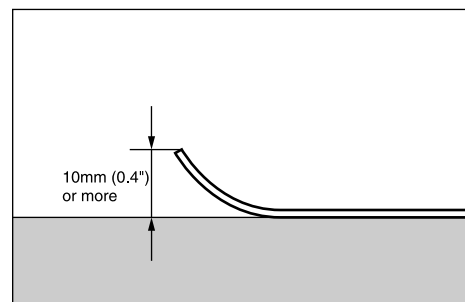
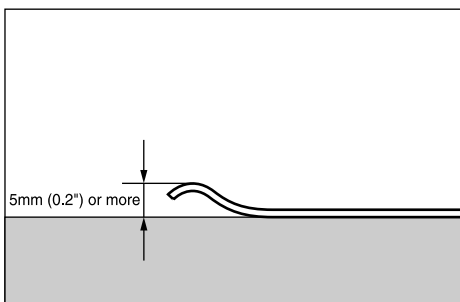

ADG014S

Original Orientation

The original can be set either in sideways or lengthway orientation, but to assure that the top/bottom orientation of the original comes out correctly when the scanned file is displayed on a computer, the correct placement must be selected.

The setting orientation differs depending on whether the width of the original is within or larger than 297mm (11.7"), which is equal to the length of the longer side of the A4-size.

- Original width is within 297mm (11.7")

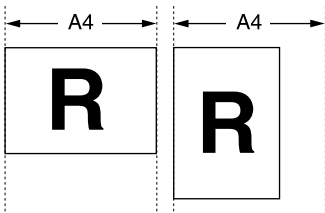

- Original width is wider than 297mm (11.7")

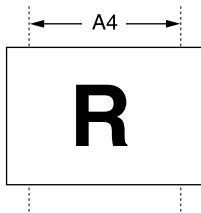





 **Note**

- Use the ADF when you perform duplex scanning.

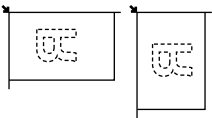
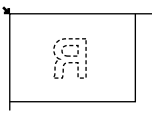
Simplex Scanning

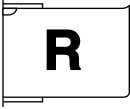
The setting orientation differs depending on whether the width of original is within or larger than 297mm (11.7").

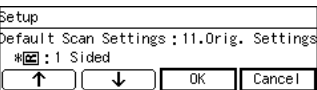
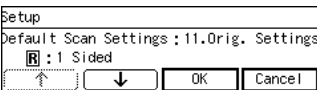
Original width	297mm (11.7") or less	wider than 297mm (11.7")
When placing an original on the exposure glass ⇒ p.116 "Placing the Original on the Exposure Glass"	Place the original so that the top edge touches the top-left of the exposure glass. 	Place the original so that the top edge touches the top-left of the exposure glass. 
When placing originals on the ADF ⇒ p.117 "Placing the Originals in the ADF"	Place the top edge of the original first. 	Place the original so that the top edge is set on the far side of the original table. 
Setting when the network TWAIN driver is used	Set [Orientation:] to  When the ADF is used, set [Side:] to "Simplex". Note <input type="checkbox"/> Set "ADF" or "Platen glass" *1 in [Document:] .	Set [Orientation:] to  When the ADF is used, set [Side:] to "Simplex". Note <input type="checkbox"/> Set "ADF" or "Platen glass" *1 in [Document:] .
Settings for Send Scan (Use [Original Settings] in [Scan Settings])	Select [S]: 1 Sided .  Note <input type="checkbox"/> Because this is the initial value of this setting, you do not need to change it.	Select [R]: 1 Sided . 

*1 Contact glass: Select when scanning from the exposure glass.

Settings for Print Scan in simplex scanning

- When you perform a Print Scan operation while scanning one side of an original, set the original in the ADF as illustrated below, regardless of the width of the originals.

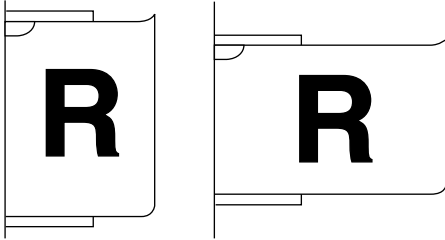

ADG025S

- Select (1 Sided Orig. → 1 Sided Print) or (1 Sided Orig. → 2 Sided Print) to perform simplex scanning, by using **[Duplex]** under **[5.Print Settings]** on this machine. See p.79 “Duplex” for details.







! Limitation

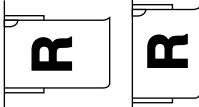

- When you select 2-sided print, the printout orientation is fixed to top to top.

Duplex Scanning

When performing duplex scanning, place the originals in the ADF.

The setting orientation differs depending on whether the width of the original is within or larger than 297mm (11.7”).

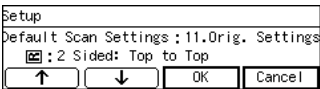
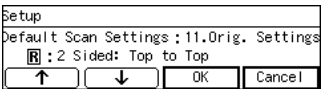
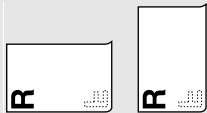
Original width	297mm (11.7”) or less	wider than 297mm (11.7”)
When placing originals on the ADF ⇒ p.117 “Placing the Originals in the ADF”	Place the original right side up, top edge first. 	Place the original right side up, in such a way that the top edge is set on the far side of the original table. 
	When the original is bound on either side: 	When the original is bound on either side: 
Setting when the network TWAIN driver is used	Set [Orientation:] to  , [Side:] to “Duplex (Top to Top)”, and [Document:] to “ADF”.	Set [Orientation:] to  , [Side:] to “Duplex (Top to Top)”, and [Document:] to “ADF”.

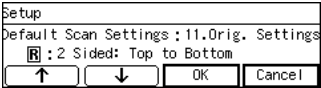
Original width	297mm (11.7") or less	wider than 297mm (11.7")
Settings for Send Scan (Use [Original Settings] in [Print Settings])	Select [L]: 2 Sided; Top to Top . 	Select [R]: 2 Sided; Top to Top . 
	When the original is bound at the top: 	When the original is bound at the top: 
Setting when the network TWAIN driver is used	Set [Orientation:] to [L] , [Side:] to " Duplex (Top to Bottom) ", and [Document:] to " ADF ".	Set [Orientation:] to [R] , [Side:] to " Duplex (Top to Bottom) ", and [Document:] to " ADF ".
Settings for Send Scan (Use [Original Settings] in [Print Settings])	[L]: 2 Sided; Top to Bottom [2 Sided:TtoB]. 	[R]: 2 Sided; Top to Bottom [2 Sided:TtoB]. 

Settings for Print Scan in duplex scanning

- When you perform a Print Scan operation while scanning both sides of originals, set the originals in the ADF as illustrated below, regardless of the width of the originals.

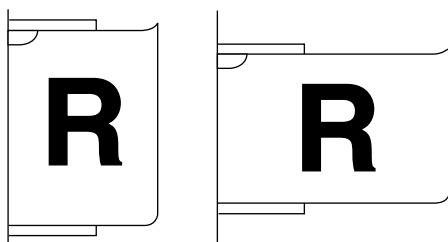

ADG025S

- Select (2 Sided Orig. → 1 Sided Print) or (2 Sided Orig. → 2 Sided Print) to perform duplex scanning, by using **[Duplex]** under **[5.Print Settings]** on this machine. See p.79 "Duplex" for details.

⚠ Limitation

- When you select duplex scanning in a Print Scan operation, scanning of the originals is fixed to top to top. This means that the originals must be bound on either side.
- When you select 2-sided print, the printout orientation is fixed to top to top.
- When the originals are bound at the top, or when you do not set the originals as illustrated above, you'll never have the printout results as expected.

Placing the Original on the Exposure Glass

Important

- ❑ Be careful not to pinch your fingers when closing the ADF.
- ❑ To activate the auto detection of an original, place the original after this machine starts up.

1 Lift the ADF.

Note

- ❑ Be sure to lift the exposure glass cover or ADF more than 30°. Otherwise, the size of the original might not be detected correctly.

2 With the side to be scanned facing down, place the original on the exposure glass, and align it with the home position and scale.

Important

- ❑ Do not press down on the exposure glass. Strong pressure on the exposure glass could cause it to break.
- ① When the original width is 297mm (11.7") or less

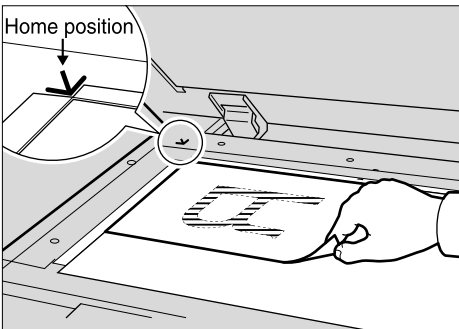

ADG015S

② When the original width is wider than 297mm (11.7")

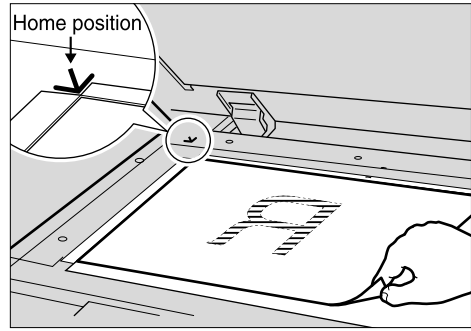

ADG016S

When a document is set in this direction, it is generally necessary to change the document setting direction at the point of transmission. ⇒ p.113 "Simplex Scanning"

3 Gently lower the ADF.

Placing the Originals in the ADF

The ADF allows you to place multiple originals at one time. Originals placed in the ADF can be scanned on one side or both sides.

❖ Precautions in placing an original in the ADF

- For information about the originals that cannot be placed in the ADF, see p.111 “Originals that cannot be set in the ADF”.

⚠ Important

- ❑ Attempting to use unsuitable originals in the ADF can lead to a misfeed and damage to the originals. Place such originals directly on the exposure glass.
- Do not set originals in the ADF in excess of the upper limit mark.
- See p.110 “The Original Sizes Available for Auto Detection” for information about the original sizes that can be detected automatically.
- Fan the originals to get air between the sheets before setting in the ADF.

1 Adjust the side guides to the size of your originals.

2 Place the originals face up (when performing duplex scans, front page up), and align them.

For information about original orientation, see p.113 “Simplex Scanning” and p.114 “Duplex Scanning”

📌 Note

- ❑ If the scan width is the same, you can set originals whose length differs from each other.
 - ❑ The originals are scanned in sequence, starting with the top page.
- ① When the original width is 297mm (11.7”) or less

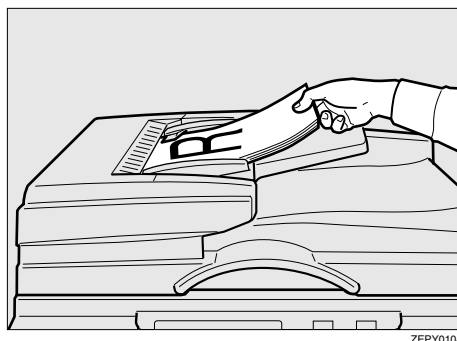

- ② When the original width is wider than 297mm (11.7”)

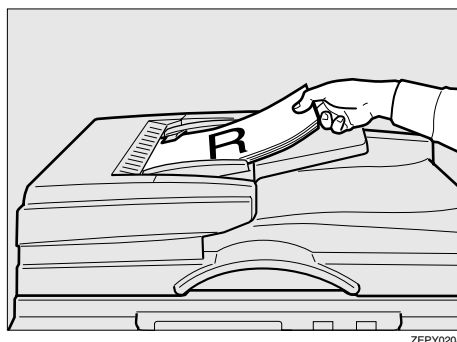

📌 Note

- ❑ When both sides of an original are scanned, the original setting direction needs to be changed regardless of the setting direction. ⇒ p.114 “Duplex Scanning”

5. Using the Network TWAIN Scanner Function

This chapter describes the operations of DeskTopBinder V2 Lite for scanning originals by using this machine as a network TWAIN scanner. In addition, some functions of the network TWAIN driver are introduced.

Procedure Breakdown

The following overview diagram shows the flow of the steps for scanning originals from a client computer using the network TWAIN driver.

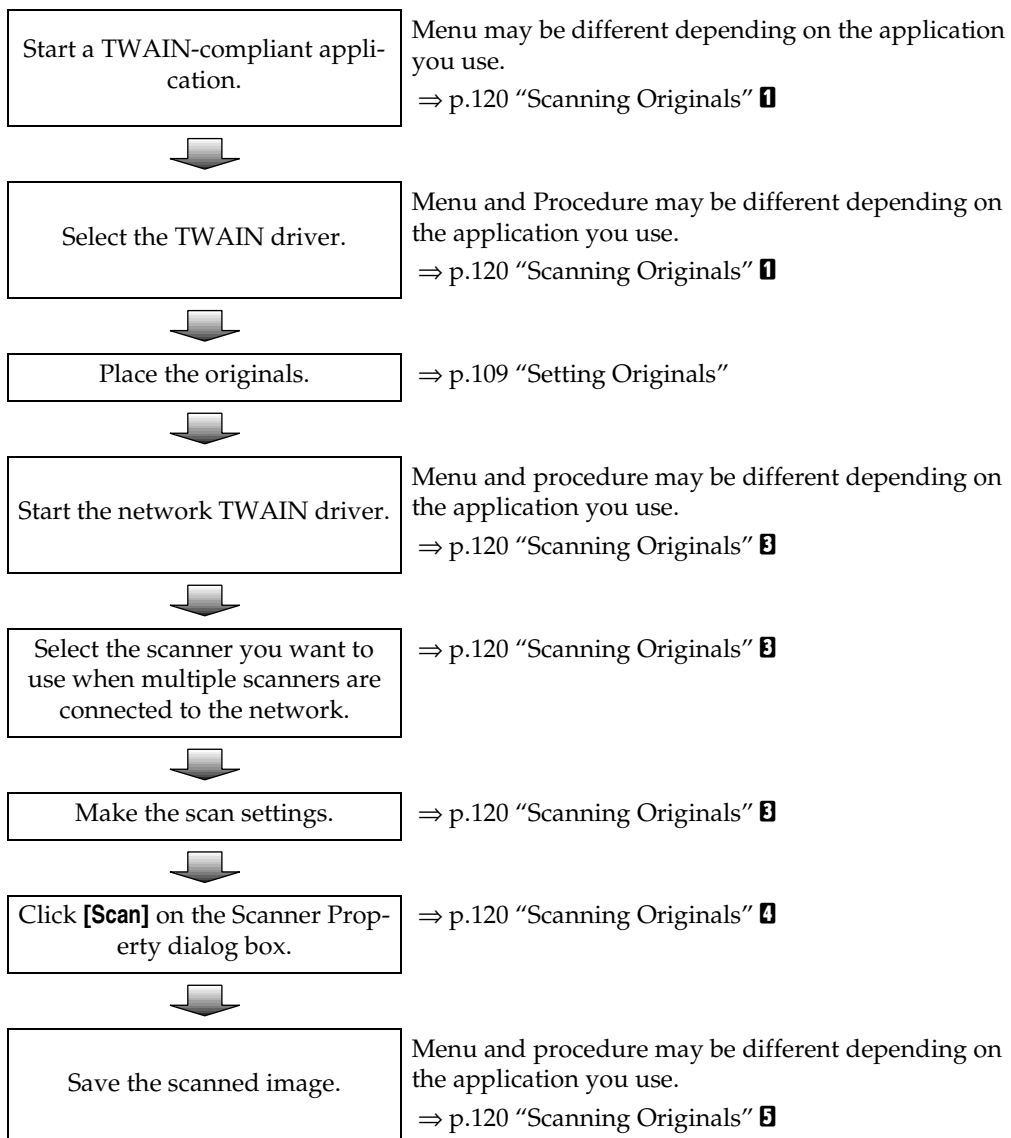

Scanning Originals

This section explains how to scan originals using the network TWAIN scanner function.

1 Start DeskTopBinder V2 Lite, and then select the scanner driver.

1 On the [Start] menu, point to [Program], point to [DeskTopBinder V2], and then click [DeskTopBinder V2].

2 Click [Scanner Settings...] on the [Tools] menu.

If the scanner is already selected, no scanner settings are necessary. Check the settings in the [File format for scanned image(s)] area, and then proceed to step

5.

3 Click [Select Scanner Driver...].

4 Select the name of the machine you want to use in the [Source] list, and then click [Select...].

5 Click [OK].

2 Place the original in the scanner.

 **Reference**

⇒ p.109 “Setting Originals”

3 Make the scan settings.

1 On the [File] menu, point to [Add Document], and then click [Scan...].

The TWAIN driver starts.

After a short while, the dialog box of the TWAIN driver that operates the scanner appears.

This dialog box is called the Scanner Properties dialog box.

 **Note**

For advanced settings, click [Detail] to display the Detail

 **Note**

The name of the scanner currently being used is shown on the title bar of the dialog box. When multiple machines are connected, make sure that the indicated machine is the machine you want to use. If it is different, click [Select Scanner] to select the scanner again.

If the machine you want to use is not displayed in the list, make sure that the IP address is configured and that the machine is correctly connected to the network. If the machine is still not displayed in the list after confirming the above, consult with your network administrator.

2 Depending on the type of original or the objective for scanning, click the appropriate button in [Mode].

- [Standard] is suitable for scanning standard originals that are comprised of mainly text.

- [Photo] is suitable for scanning originals that include photos, shaded illustrations, etc.

- [OCR] is suitable for conversion processing with an OCR (Optical Character Reading) application after scanning the original.

- [Filing] is suitable for use with filing applications, etc. window. For information about the Detail window, see TWAIN driver Help.

- 3 According to the settings of [Document:] and [Orientation:], change the other setting of the [Document] group.

 **Reference**

For information about making settings for the [Document] group, see p.113 “Simplex Scanning”, p.114 “Duplex Scanning” and TWAIN driver Help.

When you want to configure the scanning area

When you do not configure the scanning area, the area scanned is the size specified in the [Size:] box.

- 1 Click [Preview].

The original that was placed is scanned and the [Preview] dialog box appears. The scanning area in the preview is displayed within the broken lines.

- 2 Configure the scanning area by dragging a border or a corner.

When reconfiguring the area, click and drag one corner of the area towards or away from its opposite corner.

 **Note**

- Depending on the scanning resolution, the area to be scanned may be subject to restrictions. For more information about the relationship between the resolution and the scanning area, see TWAIN driver Help.

- 3 Click [Close].

 **Note**

- When an original placed in the ADF is previewed, place that original again.

- 4 Click [Scan].

When there are additional originals to scan, place the original, and then click [Continue]. When there are no more originals, click [Complete].

- 5 Save the scan file in DeskTopBinder V2 Lite.

- 1 On the [File] menu, click [Exit].

- 2 Enter the file name, and then click [OK].

The image is stored in DeskTopBinder V2 Lite, and DeskTopBinder Viewer closes.

 **Editing and printing scan files**

With DeskTopBinder V2 Lite, it is possible to edit and print scan files. For more information about how to edit and print, see DeskTopBinder V2 Lite Help.

Functions of the TWAIN Driver

The following is an introduction to the various functions of the TWAIN driver:

Reference

For more information about these functions or other functions, see TWAIN driver Help.

❖ Automatic Tilt Correction

This function automatically corrects character strings that were scanned slanted.

❖ Printing to the Image

This function allows you to imprint dates, page numbers, or your favorite characters on a scan file.

You can also change the fonts of the imprints as well as change the ascending order of images to a descending order.

❖ Scanning Mode Registration

This function allows you to register other scanning configurations that are often used as scanning modes besides the already pre-installed ones. After registration, you can quickly scan with these scanning configurations.

6. Sending Scan File by E-mail

This chapter explains how to send a scan file as an e-mail attachment.

Procedure Breakdown

The following overview diagram shows the flow of the steps for sending scan files as E-mail attachments. Note that the underlined steps are essential.

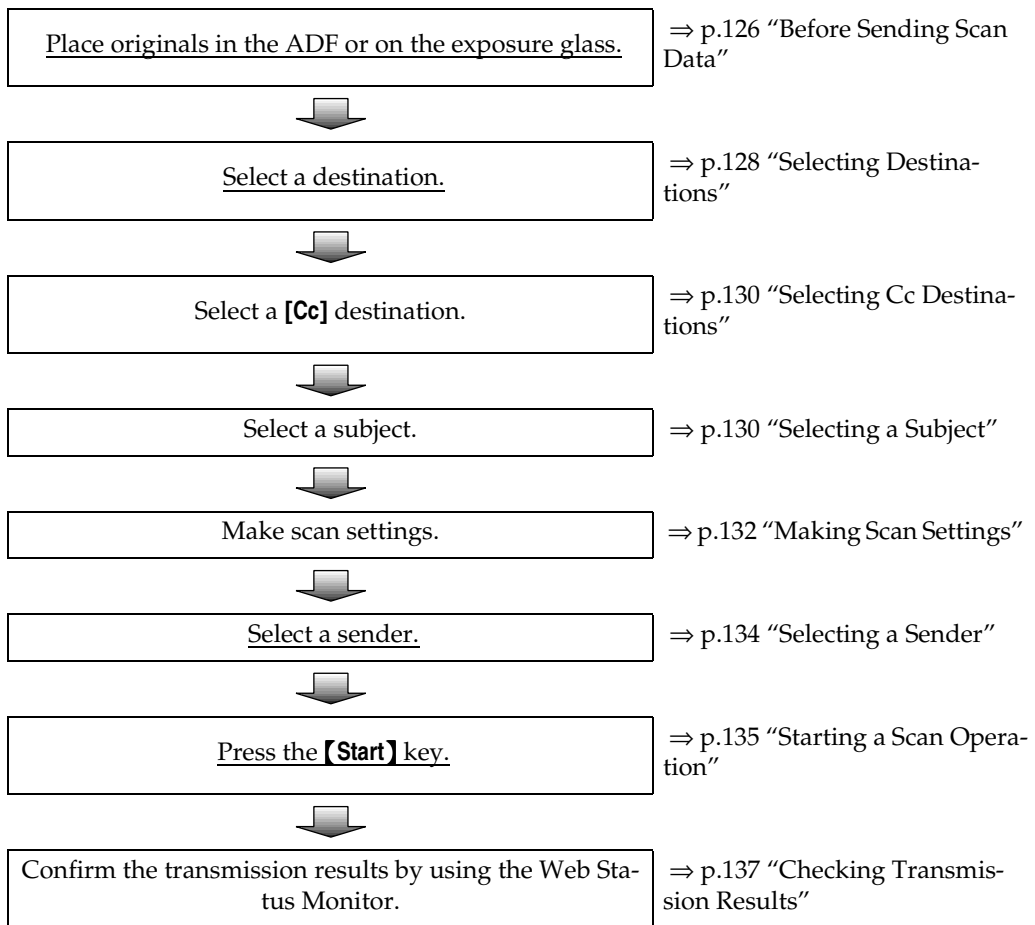

E-mail Content

Sender

- If you specify a sender of an e-mail using the **[Sender]** list on this machine, the user you have specified becomes the sender.

Note

- It is necessary to set **[Register as Sender]** to “On” to have a registered user displayed on this machine’s **[Sender]** list. The setup item **[Register as Sender]** is included under **[Configuration]** → **[E-mail SettingsE-mail Address]** → **[E-mail Address]** on the Web Status Monitor.
- If you do not specify a sender of an e-mail when **[Sender's Name Default]** is set to “Administrator's Address”, the registered administrator’s address becomes the sender. The setup item **[Sender's Name Default]** is included under **[Configuration]** → **[E-mail Settings]** on the Web Status Monitor.

Note

- It is essential to specify a sender of an e-mail, when **[Sender's Name Default]** is set to “No”.

Subject

You can select a subject of an E-mail from the **[Subject]** list displayed on this machine.

Note

- No subject appears on your E-mail message when you do not specify a subject. (Depending on the E-mail client software on the side of the receiver, such string like “No subject” appears as the subject.)

File name and file type of an e-mail attachment

A scanned image file to be sent as an E-mail attachment is automatically named as “SDOC0001.xxx” (“xxx” is a file extension). The four-digit number in the file name is count up sequentially, when you perform scanning of multiple pages, with the **[File Type]** setting is set to “Single Page”.

Note

- Scanned image files are sent in the file format that you specified in **[File Type]** under **[Scan Settings]**. See p.73 “File Type”.

Related information

The following information is automatically generated and used as body text of your E-mail message.

Note

- You cannot change the auto-generated body text.

◆ First line

The following sentence is inserted to the first line of an e-mail body.
“This E-mail was sent from <device name> (model name).”

Note

- For “<device name>”, the name that is specified for the machine’s device name is used. (You can specify the device name using **[Configuration]** → **[Basic Settings]** → **[General Settings]** → **[Device Name]**.)
- For “model name”, the product ID of this machine is automatically inserted.

❖ Date and time when scan is performed

Date and time information is inserted to the second line of an e-mail body, in the following format. "Day/Month/Year/Hour/Minute/Second/Offset from GMT"

Note

- You can set time and date using **[Date/Time(Year/Month/Day/Hr/Min/Sec)]** in **[2.Send Scan Settings]** under the Scanner Features menu.
- "Offset from GMT" shows the time offset from Greenwich Mean Time. You can specify this setting by using **[Configuration]** → **[Basic Settings]** → **[Scanner]** → **[Time Zone]** on the Web Status Monitor.

❖ Contact information

When **[Sender's Name Default]** (included under **[Configuration]** → **[E-mail Settings]** on the Web Status Monitor) is set to " Administrator's Address ", the registered administrator's e-mail address is inserted to the third line of an e-mail body, as a contact representative.

When **[Sender's Name Default]** is set to " No " and administrator's address is not registered, the contact information is omitted.

Before Sending Scan Data

Reference

See p.109 “Setting Originals” for information about how to place the originals in the ADF (Auto Document Feeder) or on the exposure glass, and about available paper size and weight.

Original Location

When you perform a Send Scan (e-mail, Send File (SMB/FTP) or Delivery Server) operation, it is not necessary to select the location (ADF or exposure glass) for scanning.

This machine automatically detects the originals placed in the ADF or on the exposure glass, and scan is performed. Note, however, that the originals in the ADF are scanned when the originals are set to on both of the ADF and the exposure glass.

Original Orientation and Scanning Sides

When you perform a Send Scan (e-mail, Send File (SMB/FTP) or Delivery Server) operation, you can specify the original orientation and scanning sides manually, by pressing **[Scan]** on the E-mail/Send File standby screen, and then selecting **[Manual]**. Instead of manually specifying these settings, you can also use the settings you have registered to “Default”, “User 1”, “User 2”, or “User 3”. See p.132 “Making Scan Settings” for details.

E-mail/Send File standby screen

Before performing a Send Scan operation, make sure that the E-mail/Send File standby screen is displayed on the machine’s display panel.

The E-mail/Send File standby screen is displayed as the Send Scan initial screen when **[7.Select Method]** (in **[2.Send Scan Settings]** under the Scanner Features menu) is set to “Send File/TWAIN”, while the Delivery Server standby screen is displayed when **[7.Select Method]** is set to “Delivery Server/TWAIN”.

- When the message “Ready” and the number of copies are displayed on the first line of the display panel, the machine is standing by for Print Scan. Press **[PrevMenu]** to return to the Select Method screen.

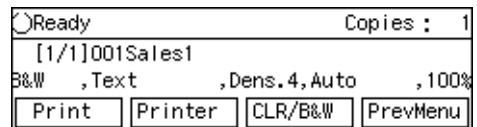

- When the message “ Connecting with PC... ” is displayed on the display panel, the machine is used from a client computer, and scanning is in progress. Wait until the job now in progress ends.

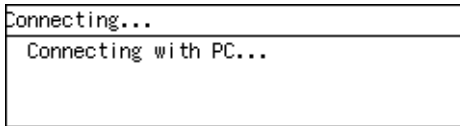

- When the message “ Connecting with PC... Set original(s) and select the settings from the PC. ” is displayed on the display panel, the machine is standing by for the network TWAIN. Press **[Exit]**.

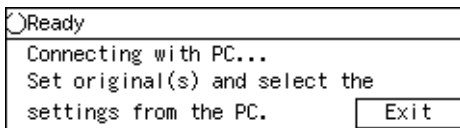

If there are no **[Exit]**, the Network TWAIN exclusive standby screen is displayed. Set **[7.Select Method]** (in **[2.Send Scan Settings]** under the Scanner Features menu) to “ Send File/TWAIN ”, and then restart the machine.

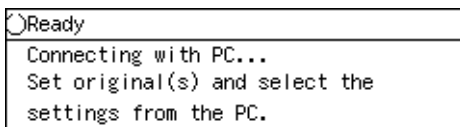

- When a send file path name is displayed at the second line of the screen, the standby screen for **[Enter Custom Send File]** is displayed. In this case, press **[PrevMenu]**.

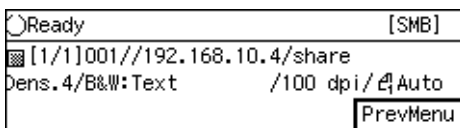

Selecting Destinations and a Subject

You can specify up to 100 destinations at a time, by selecting from the registered destinations on this machine. You can also specify Cc destinations and a subject of an e-mail.

Selecting Destinations

1 Press the **[1]** key.

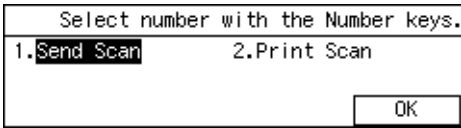

Note

- You can skip this step when the E-mail/Send File standby screen is displayed.

The E-mail/Send File standby screen is displayed.

2 Press **[Dest.]**.

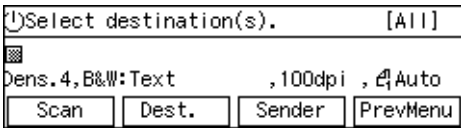

Note

- If " On " is selected for **[Auto Update Destination List]** in **[2.Send Scan Settings]** under the Scanner Features menu on this machine, the destination list is automatically updated when you press **[Dest.]**. See p.61 "Auto Update Destination List" for details.

3 While **[To:]** is highlighted, press **[Settings]**.

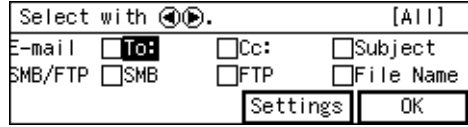

Note

- If **[To:]** is not highlighted, use the **[▶]** and **[◀]** keys to select it.

The list of the destinations that are registered to this machine appears.

4 Use **[Next]** and **[Prev.]** to scroll through the pages, and display the destination you want to select.

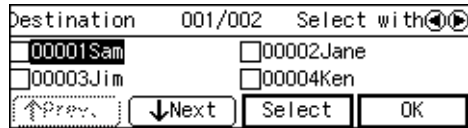

5 Use the **[▶]** and **[◀]** keys to highlight the destination you want to select, and then press **[Select]**

This selects the check box next to the destination.

6 Repeat steps **4** and **5** for selecting each of the additional destinations.

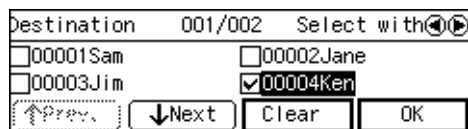

Note

- While highlighting a destination with its check box selected, press **[Clear]** to clear the check box (this deselects the destination).

To recall destinations using a title

- 1 Press the **[./*]** (Title) key.

List of titles appears on the screen.

 **Note**

- Titles are displayed according to the settings in **[Configuration]** → **[Basic Settings]** → **[Scanner]** → **[Select Title]** on the Web Status Monitor.

- 2 Use the **[▶]** or **[◀]** key to highlight the title you want to select, and then press **[OK]**.

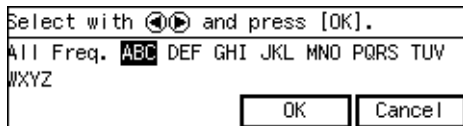

The destinations assigned to the selected title are displayed.

 **Note**

- You can select the title under which each of the registered destinations is assigned in **[Configuration]** → **[E-mail Settings]** → **[E-mail Address]** → **[Assign Title]** on the Web Status Monitor.

- 3 Highlight the destination you want to select, and then press **[Select]**.

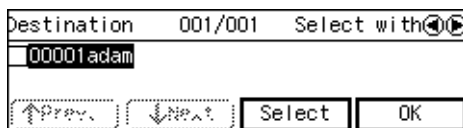

 **Note**

- While highlighting a destination with its check box selected, press **[Clear]** to clear the check box (this deselects the destination).

- If you want to select from another title, press the **[./*]** (Title) key. This displays list of titles again.

To recall all available destinations

- 1 Press the **[./*]** (Title) key.

List of titles appears on the screen.

- 2 Use the **[▶]** or **[◀]** key to highlight **[All]**, and then press **[OK]**.

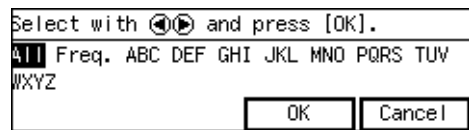

- 7 When you are finished, press **[Exit]**.

This returns to the screen that was displayed in step 3.

 **Note**

- When no cc destination and subject is necessary, press **[OK]** here. The E-mail/Send File standby screen is displayed, and the first destination you have selected appears at the second line of the screen. When you have selected multiple destinations, you can confirm them by using the **[▶]** and **[◀]** keys.

Selecting Cc Destinations

You can specify destinations to send “carbon copies” of an E-mail message as necessary. Up to 100 destinations can be selected per an E-mail message in all, including those specified as [To:] and [Cc:].

- 1 Use the [▶] and [◀] keys to highlight [Cc:], and then press [Settings].

Select with ◀▶. [E-mail]		[All]
E-mail	<input checked="" type="checkbox"/> To:	<input type="checkbox"/> Cc: <input type="checkbox"/> Subject
SMB/FTP	<input type="checkbox"/> SMB	<input type="checkbox"/> FTP <input type="checkbox"/> File Name
		[Settings] [OK]

The list of the destinations that are registered to this machine appears.

- 2 Follow the same procedure as step 4 through 6 under “Selecting Destinations”.
- 3 When you are finished, press [Exit].

This returns to the screen that was displayed in step 1.

Note

- When no subject is necessary, press [OK] here. The E-mail/Send File standby screen is displayed.
- The second line of the screen shows the first destination that you have specified for [To:] in “Selecting Destinations”. You can confirm all the specified destinations by using the [▶] and [◀] keys, when you have selected multiple destinations.
- You cannot confirm the “Cc” destinations on the E-mail/Send File standby screen.

Selecting a Subject

- 1 Use the [▶] and [◀] keys to highlight [Subject], and then press [Settings].

Select with ◀▶.		[All]
E-mail	<input type="checkbox"/> To:	<input type="checkbox"/> Cc: <input checked="" type="checkbox"/> Subject
SMB/FTP	<input type="checkbox"/> SMB	<input type="checkbox"/> FTP <input type="checkbox"/> File Name
		[Settings] [OK]

The list of the subjects that are registered to this machine appears.

- 2 Use [Next] and [Prev.] to scroll through the pages, and display the subject you want to select.

Email Subject	01/02	Select with ◀▶
<input checked="" type="checkbox"/> Sales-Daily		
<input type="checkbox"/> Sales-Weekly		
<input type="button" value="↑Prev."/>	<input type="button" value="↓Next"/>	[Select] [OK]

- 3 Use the [▶] and [◀] keys to highlight the subject you want to select, and then press [Select].

This selects the check box next to the subject.

Note

- Selecting another subject automatically deselects the subject currently selected (so the check mark next to the subject is cleared).
- While highlighting a subject with its check box selected, press [Clear] to clear the check box (this deselects the subject).

- 4 Press [Exit].

This returns to the screen that was displayed in step 1.

5 Press [OK].

This returns to the E-mail/Send File standby screen.

○Ready	[E-mail]	[All]
■ [1/1]001Ken		⏪ ⏩
Dens. 4, B&W: Text	, 100dpi	, ⏪ Auto
Scan	Dest.	Sender PrevMenu

Note

- ❑ The second line of the screen shows the first destination that you have specified for **[To:]** in “Selecting Destinations”. You can confirm all the specified destinations by using the **⏩** and **⏪** keys, when you have selected multiple destinations.
- ❑ You cannot confirm the subject or the “Cc” destination on the E-mail/Send File standby screen.

Making Scan Settings

Follow the steps below to configure scan settings before you perform a Send Scan operation. If you skip the following steps, scan is performed using the settings that you have configured and registered to **[Default]** in **[4.Scan Settings]** under the Scanner Features menu.

1 Press **[Scan]**.

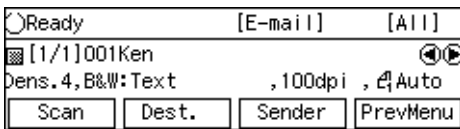

The Scan Settings screen is displayed.

2 Select whether you configure the scan settings manually, or use one of the user settings you have registered.

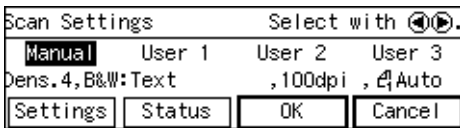

Reference

You can confirm the scan settings you have registered. See p.133 “Confirming the Scan Settings”.

Note

- Press **[Cancel]** if you want to use the settings you have registered to **[Default]**.
- You cannot edit and save the settings that you have registered to **[User 1]**, **[User 2]** and **[User 3]** here. If you want to use one of the user settings while changing some of them, recall the user setting you want to use by highlighting it and pressing **[OK]** first. And then, change the settings by selecting **[Manual]**.

To recall a registered scan settings

1 Use the **[▶]** or **[◀]** key to highlight **[User 1]**, **[User 2]** or **[User 3]** on the screen, and then press **[OK]**.

This returns to the E-mail/Send File standby screen, and the corresponding scan settings are displayed on the third line of the screen.

To configure scan settings manually

1 Use the **[▶]** or **[◀]** key to highlight **[Manual]** on the screen, and then press **[Settings]**.

The first page of the Scan Settings screen (Scan Settings 1/3) is displayed.

2 Use **[Next]** or **[Prev.]** to scroll through the pages, use the **[▶]** or **[◀]** key to highlight the setup item you want to change, and then press **[Settings]**.



Reference

See p.70 “Information to Register in [Send Scan Settings]” for details about each of the setup items.

- ③ Highlight the option you want to select by using the [▶] or [◀] key, and then press [OK].

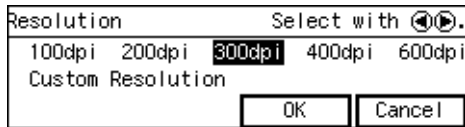

Note

- ❑ Pressing [Cancel] discards the selected option, and returns to the previous screen.
- ❑ When you select “ Custom Resolution ” for [Resolution] and/or “ Custom Area Setting ” for [Scan Size], use the number keys to specify the values.

- ④ Repeat steps ② and ③ as necessary.

- ⑤ When you are finished, press [PrevMenu].

This returns to the Scan Settings screen.

- ⑥ Press [OK].

This returns to the E-mail/Send File standby screen, and the current scan settings are displayed on the third line of the screen.

Confirming the Scan Settings

You can confirm the current scan settings, or the scan settings that you have registered to [Default], [User 1], [User 2] or [User 3].

Note

- ❑ You can confirm the [Default] settings by selecting [Manual] in step ② below, unless you configure the scan settings manually. After you have manually configured the scan settings, selecting [Manual] displays the current settings.

- ① Press [Scan].

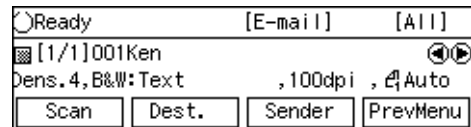

The Scan Settings screen is displayed.

- ② Use the [▶] or [◀] key to highlight [Manual], [User 1], [User 2] or [User 3] on the screen, and then press [OK].

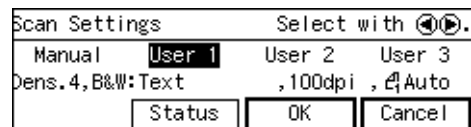

The status screen appears.

- ③ Use [Next] and [Prev.] to display the setting of the setup item you want to confirm.

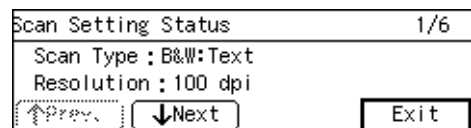

- ④ When you are finished, press [Exit].

- ⑤ Press [Cancel] or [OK].

Note

- ❑ If you want to apply the scan settings you selected in step ②, press [OK]. If you want to exit the status screen without changing anything, press [Cancel].

This returns to the E-mail/Send File standby screen.

Selecting a Sender

You can select a sender of an e-mail using the **[Sender]** list on this machine. The **[Sender]** list displays the registered users, whose **[Register as Sender]** settings (included under **[Configuration]** → **[E-mail Settings]** → **[E-mail Address]** on the Web Status Monitor) are set to “ On ”.

1 Press **[Sender]**.

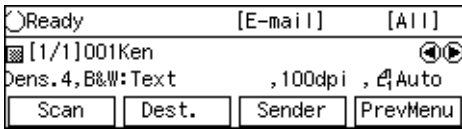

The list of the senders that are registered to this machine appears.

2 Use **[Next]** and **[Prev.]** to scroll through the pages, use the **[▶]** and **[◀]** keys to highlight the sender you want to select, and then press **[Select]**.

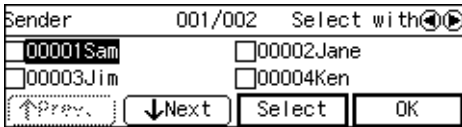

This selects the check box next to the sender’s name.

Note

- ❑ Selecting another sender automatically deselects the sender currently selected (so the check mark next to the sender’s name is cleared).
- ❑ While highlighting a sender with its check box selected, press **[Clear]** to clear the check box (this deselects the sender).

- ❑ When you select a user whose **[Sender’s Password]** setting (included under **[Configuration]** → **[E-mail Settings]** → **[E-mail Address]** on the Web Status Monitor) is set to “ On ”, a dialog box for entering a password appears. Enter the registered password using the number keys.
- ❑ You can recall specific senders by selecting a title. See p.129 “To recall destinations using a title”.

3 Press **[OK]**.

This returns to the E-mail standby screen.

Performing Scan Operation

Starting a Scan Operation

To start with originals in the ADF

- 1 Confirm that the E-mail standby screen is displayed.

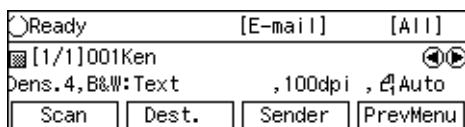

When “Select destination(s).” is displayed, no destination is selected. Select a destination to display “Ready” on the screen.

- 2 Press the **[Start]** key.

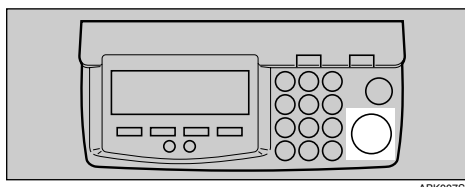

ABK0075

Scanning originals in the ADF starts.

Note



- To interrupt scanning, press the **[Clear/Stop]** key.
- When “Show Options after Each Scan Job” is selected for **[End of Scan Option]** under **[2.Send Scan Settings]**, a screen for selecting the next operation appears after scanning of all the originals in the ADF is completed.
 - Press **[Add]** to continue scanning to add scanned data to the current image file.

- Press **[New Job]** to finish the current scanning job and send the scanned data. You can start a new job with the current settings after the scanned data is sent.
- Press **[OK]** to finish the current scanning job, send the scanned data, and then return to the initial screen when the power is turned on. If you do not press any key, this machine acts as **[OK]** is pressed, after the specified period.

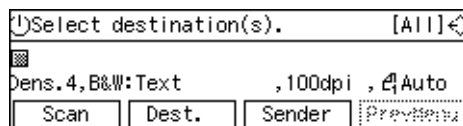
When scanning finishes properly, the e-mail is sent to the e-mail (SMTP) server.  appears at the upper right corner of the screen while the e-mail is sent.



Note

- You cannot perform any operations while  is displayed on the screen.
 - Do not turn the power of this machine off while  is displayed on the screen.
-  disappears when the e-mail has been sent to the e-mail (SMTP) server, and the E-mail standby screen appears.

To start with an original on the exposure glass

1 Confirm that the E-mail standby screen is displayed.

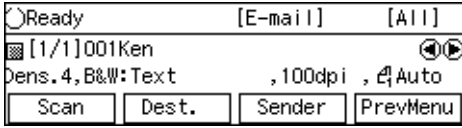

When "Select destination(s)." is displayed, no destination is selected. Select a destination to display "Ready" on the screen.

2 Press the **[Start]** key.

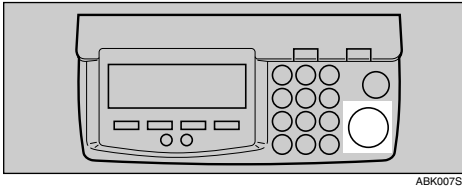

Scanning the original on the exposure glass starts.

Note

- To interrupt scanning, press the **[Clear/Stop]** key.

After the original is scanned properly, the message "Set the next original(s) and press the Start key, or press [Finish] to complete." appears.

3 Place the next original on the exposure glass, and then press the **[Start]** key.

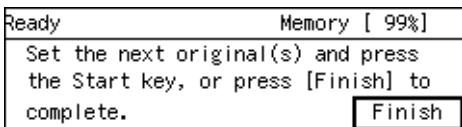

4 Repeat step **3** as necessary.

5 Press **[Finish]** when all the originals are scanned.



Note

- When "Show Options after Each Scan Job" is selected for **[End of Scan Option]** under **[2.Send Scan Settings]**, a screen for selecting the next operation appears after you press **[Finish]**.

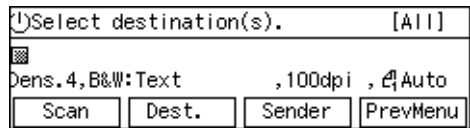
When scanning finishes properly, the e-mail is sent to the e-mail (SMTP) server.  appears at the upper right corner of the screen while the e-mail is sent.



Note

- You cannot perform any operations while  is displayed on the screen.
- Do not turn the power of this machine off while  is displayed on the screen.
-  disappears when the e-mail has been sent to the e-mail (SMTP) server, and the E-mail standby screen appears.

Checking Transmission Results

Follow the steps below to check transmission results using the Web Status Monitor on a client computer.

- 1** Start a Web browser, and then enter this machine's IP address in the address bar.

 **Reference**

See p.85 "To access this machine from a web browser"

 **Note**

- You can confirm the IP address of this machine by selecting **[IP Address]** in **[1.System Settings]** under the Scanner Features menu.

The top Page of the Web Status Monitor appears.

- 2** On the main menu, click **[Admin Info.]**.

- 3** On the sub-menu, click **[Send Info.]**.

- 4** Check the transmission result.

 **Note**

- Up to 20 transmission results are displayed in the **[Send Info.]** list at a time. Each time you perform a Send Scan operation, the list is updated and only the latest 20 transmission results are displayed.
- The transmission results are cleared when the power of this machine is turned off.
- In the **[Status]** column, **[Standby]**, **[Sending]**, **[Complete]**, or **[Not Sent]** is displayed.
- If an e-mail or a file could not be sent for any reason, **[Not Sent]** appears in the **[Status]** column.
- The **[Send Type]** column indicates the type of transmission: **[E-mail]**, **[SMB]**, **[FTP]**, **[Delivery]** or **[Print Scan]**.
- The number of original pages that are scanned appears in the **[Pages]** column.

7. Sending Scan File by Scan to Folder

This chapter explains how to send a scan file to a Windows shared folder. In this chapter, the following two types of Scan to Folder procedures are explained separately:

- Procedures to send a scanned file to a registered shared folder.
- Procedures to send a scanned file to a shared folder that is not registered to this machine. This function is called "Enter Custom Send File".

Sending a Scanned File to a Registered Shared Folder

By using the control panel of this machine, you can send a scanned file to a Windows shared folder that is registered to this machine.

Procedure Breakdown

The following overview diagram shows the flow of the steps for sending a scanned file to a Windows shared folder that is registered to this machine. Note that the underlined steps are essential.

Note

- Some of the steps such as making scan settings are identical to those explained under "Sending Scan Files by E-mail". See the relevant pages shown to the right of the following overview diagram.

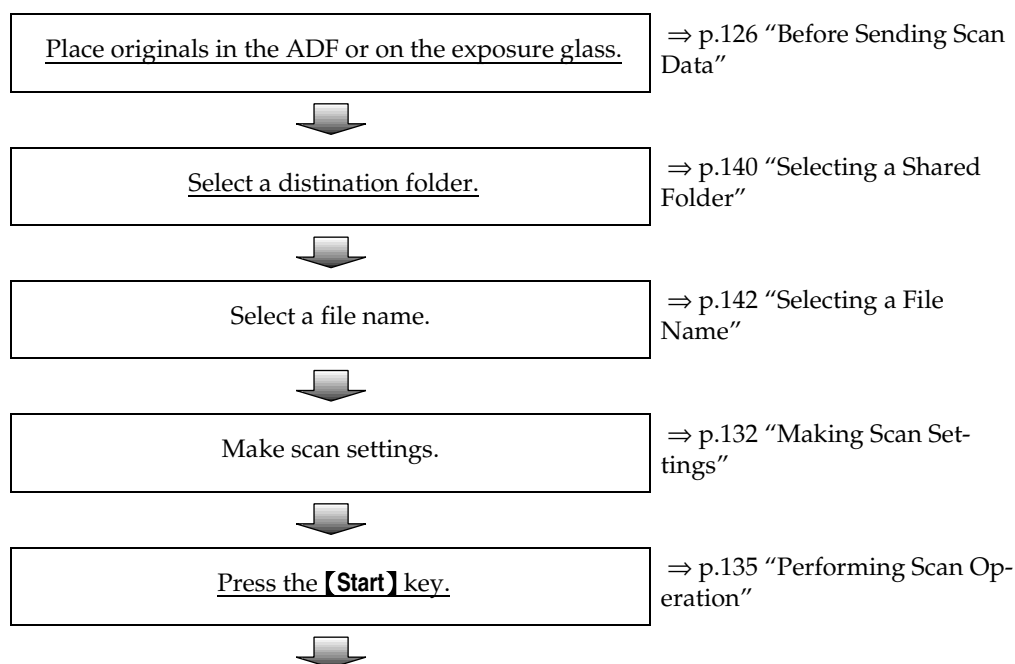

Confirm the transmission results by using the Web Status Monitor. ⇒ p.137 “Checking Transmission Results”

Selecting a Shared Folder

You can select a single shared folder as a destination to which you send a scanned file. Follow the steps below to select a shared folder.

1 Press the **[1]** key.

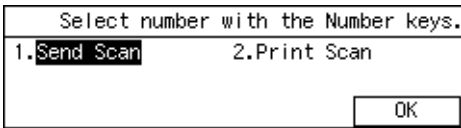

Note

- You can skip this step when the E-mail/Send File standby screen is displayed.

The E-mail/Send File standby screen is displayed.

2 Press **[Dest.]**.

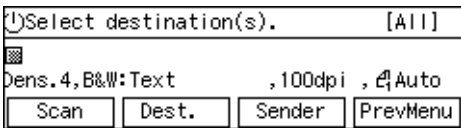

Note

- If “ On ” is selected for **[Auto Update Destination List]** in **[2.Send Scan Settings]** under the Scanner Features menu on this machine, the destination list is automatically updated when you press **[Dest.]**. See p.61 “Auto Update Destination List” for details.

3 Press the **[▶]** or **[◀]** key to highlight **[SMB]**, and then press **[Settings]**.



The list of the shared folders that are registered to this machine appears.

4 Use **[Next]** and **[Prev.]** to scroll through the pages, and display the shared folder name you want to select.

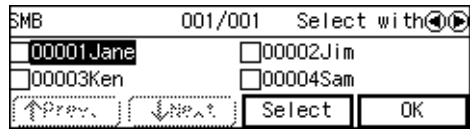

5 Use the **[▶]** and **[◀]** keys to highlight the shared folder name you want to select, and then press **[Select]**.

This selects the check box next to the shared folder name.

Note

- Because you can select only one shared folder, selecting another folder automatically deselects the folder currently selected (so the check mark next to the folder name is cleared).

To recall shared folders using a title

1 Press the [./*] (Title) key.

List of titles appears on the screen.

Note

- Titles are displayed according to the settings in [Configuration] → [Basic Settings] → [Scanner] → [Select Title] on the Web Status Monitor.

2 Use the [▶] or [◀] key to highlight the title you want to select, and then press [OK].

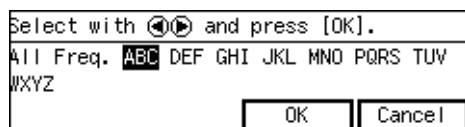

The shared folders assigned to the selected title are displayed.

Note

- You can select the title under which each of the registered destinations is assigned in [Configuration] → [File Send Settings] → [File Send Path] → [Assign Title] on the Web Status Monitor.

3 Highlight the shared folder name you want to select, and then press [Select].

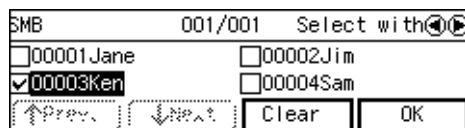

This selects the check box next to the folder name.

To recall all available destinations

1 Press the [./*] (Title) key.

List of titles appears on the screen.

2 Use the [▶] or [◀] key to highlight [All], and then press [OK].

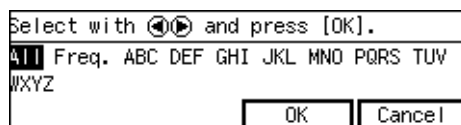

6 Press [Exit].

The message "Enter protection code for destination." appears.

7 Enter the protection code using the number keys.

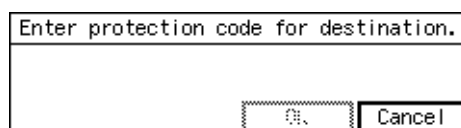

Note

- Enter the four- through eight-digit number that is specified in [Configuration] → [File Send Settings] → [File Send Path] → [Protected Password] on the Web Status Monitor.

8 Press [OK].

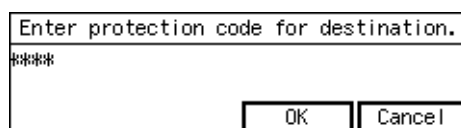

This returns to the screen that was displayed in step 3.

Note

- When you do not specify a file name, press **[OK]** here. The E-mail/Send File standby screen is displayed, and the shared folder name that you have selected appears at the second line of the screen.

Selecting a File Name

You can specify a file name (actually a prefix string for a file name) for the scanned file to be sent to the shared folder. When you do not specify a file name, the default file name "DOC" is used automatically.

- 1** While the E-mail/Send File standby screen is displayed, press **[Dest.]**.

The screen for selecting destinations appears.

Note

- If this screen is already displayed, you can skip this step.

- 2** Use the **[▶]** and **[◀]** keys to highlight **[File Name]**, and then press **[Settings]**.

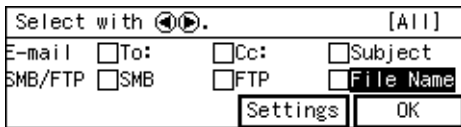

The list of the file names that are registered to this machine appears.

- 3** Use **[Next]** and **[Prev.]** to scroll through the pages, and display the file name you want to select.



- 4** Use the **[▶]** and **[◀]** keys to highlight the file name you want to select, and then press **[Select]**.

This selects the check box next to the file name.

Note

- Selecting another file name automatically deselects the file name currently selected (so the check mark next to the file name is cleared).
- While highlighting a file name with its check box selected, press **[Clear]** to clear the check box (this deselects the file name).

- 5** Press **[Exit]**.

This returns to the screen that was displayed in step **2**.

- 6** Press **[OK]**.

This returns to the E-mail/Send File standby screen.

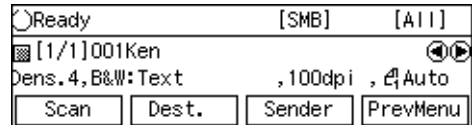

Using [Enter Custom Send File] to Send a Scanned File to an Unregistered Shared Folder

By using the **[Enter Custom Send File]** function on the Web Status Monitor, you can send a scanned file to any of Windows shared folders that you have an access right.

Procedure Breakdown

The following overview diagram shows the flow of the steps for sending a scanned file to a Windows shared folder using the Web Status Monitor. Note that the underlined steps are essential.

Note

- Some of the steps such as making scan settings are identical to those explained under “Sending Scan Files by E-mail”. See the relevant pages shown to the right of the following overview diagram.

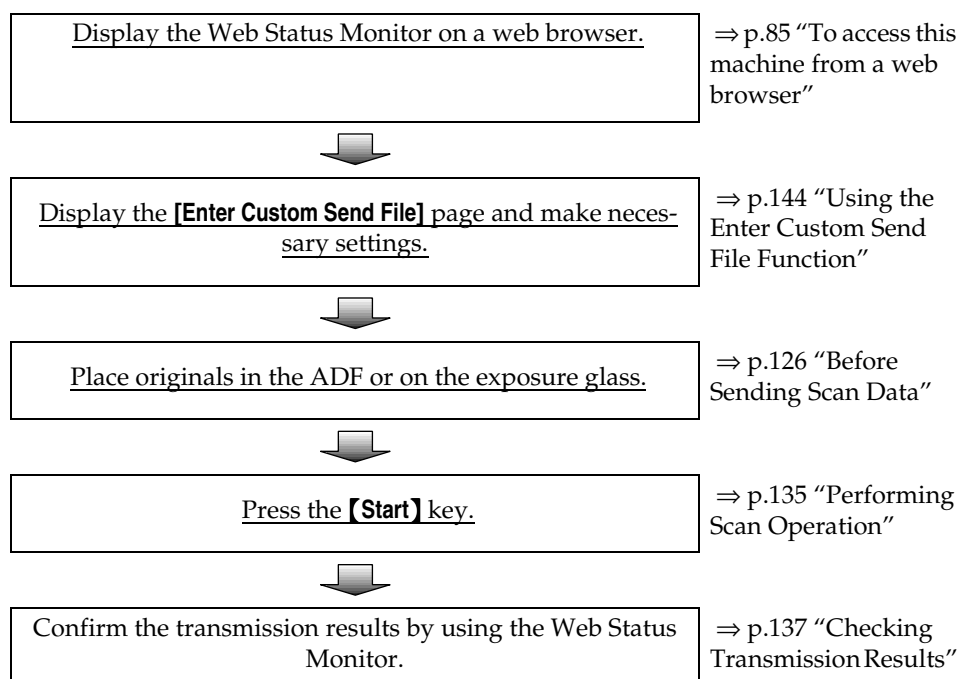

Using the Enter Custom Send File Function

Follow the steps below to send a scanned file to a Windows shared folder using the **[Enter Custom Send File]** function.

- 1** Start a Web browser on a client computer, and then enter the IP address of this machine in the address bar.

 **Reference**

See p.85 "To access this machine from a web browser"

 **Note**

- You can confirm the IP address of this machine by selecting **[IP Address]** in **[1.System Settings]** under the Scanner Features menu.

The top page of the Web Status Monitor appears.

- 2** On the main menu, click **[Enter Custom Send File]**.

The **[Enter Custom Send File]** page appears.

- 3** Make the necessary settings on the screen.

 **Reference**

See p.70 "Information to Register in **[Send Scan Settings]**" for information about the setup items at the top through middle of the **[Enter Custom Send File]** page ("Scan Type" through "File Type").

See p.112 "Original Orientation" for information about **[Original Setting/Orientation]**.

See "Information to set in **[File Send]** group" below for information about the settings included under **[File Send]** group.

Information to set in **[File Send]** group

❖ **File Send Path**

Enter the path to the shared folder where you are sending the file, in the format of "\\host name\folder name" or "\\IP address\folder name".

You can also specify a shared folder that is not specified on the **[Configuration: File Send Path]** page.

 **Note**

- The specified IP address is effective only for the computer running Windows 2000/XP or Windows NT as operating system. An IP address cannot be specified for a host running Windows 98/Me as operating system.

❖ **Login User Name**

Enter a user name with shared folder access, in the format of "work group name\user name" or "domain name\user name".

Note

- If the shared folder is on the FTP server, enter a user name with FTP server access.

❖ Login Password

Enter the password for the user displayed in the [**Login User Name**] box. Each password character appears as "*".

Note

- When accessing a shared folder that is password protected under Windows 95/98/98 SE/Me, enter the password.

❖ [Test]

Click to check whether connection to the specified shared folder is enabled when data is entered in the [**File Send Path**], [**Login User Name**], and [**Login Password**] boxes.

❖ File Name

Enter the name of the file to store, using up to 20 characters.

1**4** When everything is the way you want, click [OK].

The message "Custom Send File has been set. To reconfigure, click Enter Custom Send File" appears on the computer, and the settings you made are sent to this machine.

At this time, this machine stands by for scanning, and "Ready" message appears on the display panel of this machine.

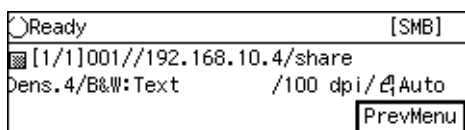
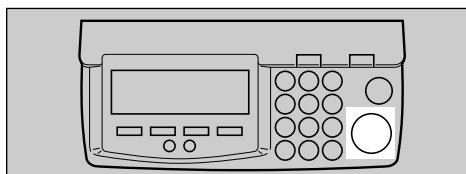
**5** Place originals.**6** Press the [Start] key.

ABK007S

Scanning starts.

Note

- To interrupt scanning, press the [**Clear/Stop**] key.

Reference

When you place the original on the exposure glass, see p.136 “To start with an original on the exposure glass”.

When scanning finishes properly, the file is sent to the shared folder.  appears at the upper right of the screen while the file is sent.

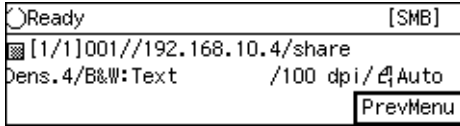

Note

You cannot perform operations on this machine while  is displayed.

7 Press [PrevMenu].

The display of this machine returns to the standby screen that had been displayed before you started the **[Enter Custom Send File]** operation.

Note

Be sure to press **[OK]** to go back to a standby screen on this machine before performing another **[Enter Custom Send File]** operation. If you start another **[Enter Custom Send File]** operation without displaying a standby screen on the machine, the message “Unable to make configurations because Scanner is currently in use. Please try again later.” appears on the Web Status Monitor.

Scanned Image Files Sent to Shared Folders

This section describes how the file name and the file location of a scanned file are determined when you perform a Scan to Folder operation.

File Locations

A scanned file created by a Scan to Folder operation is sent to a shared folder that you specified, and is saved in a sub-folder inside of the specified folder. The sub-folder name is identical to the device name of this machine.

- Example 1:
Specified folder: \\computer-name\folder
Device name of this machine: RNP6219DA
File location:
 \\computername\folder\RNP6219DA

Note

- You can specify the device name of this machine using **[Configuration]** → **[Basic Settings]** → **[General Settings]** → **[Device Name]**.

File Names

Files created by a Scan to Folder operation are named as described below in accordance with the file name you specified.

In case you did not specify a file name, the default file name "DOC" applies.

Note

- It is essential to specify a file name when you use the **[Enter Custom Send File]** function.

❖ File names with time

When **[File Name + Time]** (included under **[Configuration]** → **[File Send Settings]** → **[File Send]** on the Web Status Monitor) is set to "On", file names are generated in the following manner.

"Specified file name/Year/Month/Day/Hour/Minute/Second/(4-digit sequential number)"

- Example 2:
Specified file name: image
File format: single page
Pages: black white, text
Original page count: 2, two-sided
Time when scanned: 2003/9/16/13:07:21
The following files are generated:
 image030916130721(0001).TIF
 image030916130721(0002).TIF
 image030916130721(0003).TIF
 image030916130721(0004).TIF
- Example 3:
Specified file name: (none)
File format: multi-page TIFF
Original type: colour, full colour
Pages: 2, two-sided
Time when scanned: 2003/9/16/13:07:21
The following files are generated:
 DOC030916130721(0001).PDF

❖ **File names without time**

When **[File Name + Time]** (included under **[Configuration]** → **[File Send Settings]** → **[File Send]** on the Web Status Monitor) is set to “ Off ”, file names are generated in the following manner.

“Specified file name/(4-digit sequential number)”

- Example 4:
Specified file name: image
File format: single page
Original type: black white, text
Pages: 2, two-sided
Time when scanned: 2003/9/16 /13:07:21

The following files are generated:

- image(0001).TIF
- image(0002).TIF
- image(0003).TIF
- image(0004).TIF

- Example 5:
Specified file name: (none)
File format: multi-page TIFF
Original type: colour, full colour
Original page count: 2, two-sided
Time when scanned: 2003/9/16 /13:07:21

The following files are generated:

- DOC(0001).PDF

 **Note**

- ❑ All the files created in the examples 2 to 5 are saved to the same folder, which is explained in the example 1.
- ❑ When you send scan files to the shared folder that you have already sent scan files before, be sure to assign a different file name if **[File Name + Time]** is set to “ Off ”. If you specify the same file name and file type that you specified in the previous Send File operation, the previous scan files are overwritten with new ones.

 **Reference**

For details about file formats and extensions, see p.73 “File Type”.

8. Sending Scan File by Scan to FTP

This chapter explains procedures to send a scanned file to an FTP server.

Procedure Breakdown

The following overview diagram shows the flow of the steps for sending a scanned file to an FTP server that is registered to this machine. Note that the underlined steps are essential.

Note

- Some of the steps such as making scan settings are identical to those explained under "Sending Scan Files by E-mail". See the relevant pages shown to the right of the following overview diagram.

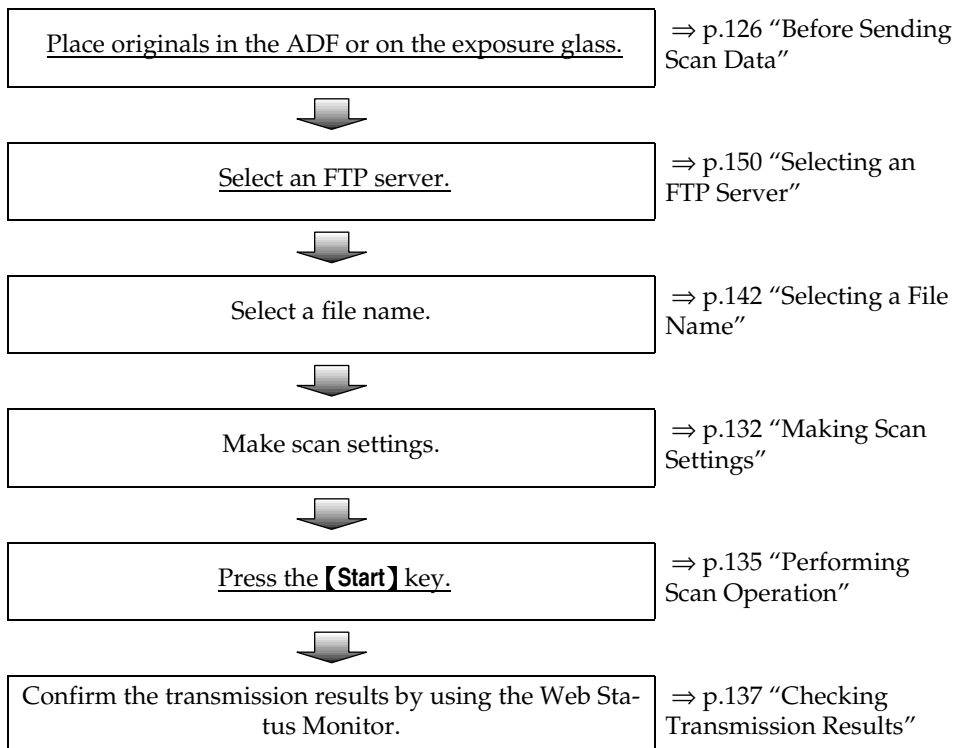

Selecting an FTP Server

You can select a single FTP server as a destination to which you send a scanned file. Follow the steps below to select an FTP server.

1 Press the **[1]** key.

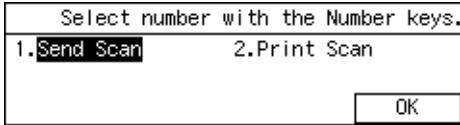

Note

- You can skip this step when the E-mail/Send File standby screen is displayed.

The E-mail/Send File standby screen is displayed.

2 Press **[Dest.]**.

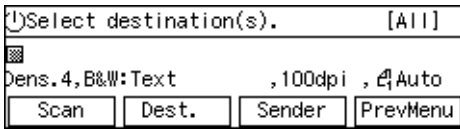

Note

- If " On " is selected for **[Auto Update Destination List]** in **[2.Send Scan Settings]** under the Scanner Features menu on this machine, the destination list is automatically updated when you press **[Dest.]**. See p.61 "Auto Update Destination List" for details.

3 Press the **[▶]** or **[◀]** key to highlight **[FTP]**, and then press **[Settings]**.

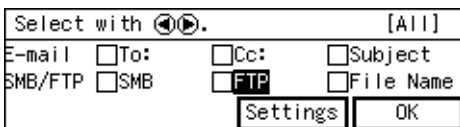

The list of the FTP servers that are registered to this machine appears.

4 Use **[Next]** and **[Prev.]** to scroll through the pages, and display the FTP server name you want to select.



5 Use the **[▶]** and **[◀]** keys to highlight the FTP server name you want to select, and then press **[Select]**.

This selects the check box next to the FTP server name.

Note

- Because you can select only one FTP server, selecting another FTP server automatically deselects the FTP server currently selected (so the check mark next to the FTP server name is cleared).

To recall FTP servers using a title

1 Press the **[./*]** (Title) key.

List of titles appears on the screen.

Note

- Titles are displayed according to the settings in **[Configuration]** → **[Basic Settings]** → **[Scanner]** → **[Select Title]** on the Web Status Monitor.

- 2 Use the [▶] or [◀] key to highlight the title you want to select, and then press [OK].

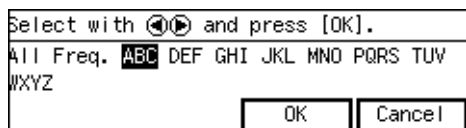

The FTP servers assigned to the selected title are displayed.

Note

- You can select the title under which each of the registered destinations is assigned in [Configuration] → [E-mail Settings] → [E-mail Address] → [Assign Title] on the Web Status Monitor.

- 3 Highlight the FTP server name you want to select, and then press [Select].

This selects the check box next to the FTP server name.

To recall all available destinations

- 1 Press the [/*] (Title) key.

List of titles appears on the screen.

- 2 Use the [▶] or [◀] key to highlight [All], and then press [OK].

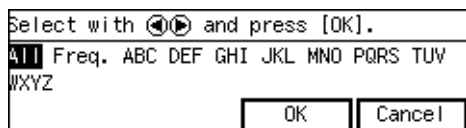

- 6 Press [OK].

The message "Enter protection code for destination." appears.

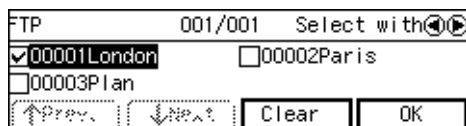

- 7 Enter the protection code using the number keys.

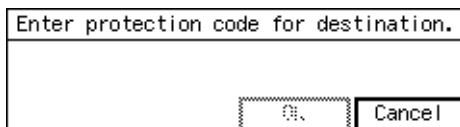

Note

- Enter the four- through eight-digit number that is specified in [Configuration] → [File Send Settings] → [FTP Server] → [Protected Password] on the Web Status Monitor.

- 8 Press [OK].

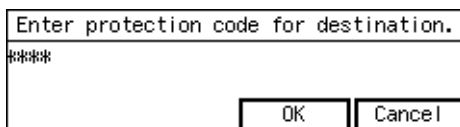

This returns to the screen that was displayed in step 3.

- 9 Press [OK].

This returns to the E-mail/Send File standby screen.

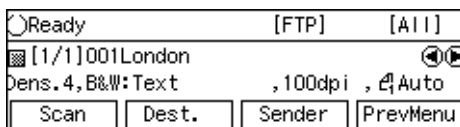

Scanned Image Files Sent to FTP Servers

This section describes how the file name and the file location of a scanned file are determined when you perform a Scan to FTP operation.

File Locations

A scanned file created by a Scan to FTP operation is sent to a folder on the FTP server that you specified, and is saved in a sub-folder inside of the specified folder. The sub-folder name is identical to the device name of this machine.

- Example 1:
 Specified FTP server: \\FTPserver\folder
 Device name of this machine: RNP6219DA
 File location:
 \\FTPserver\folder\RNP6219DA

 **Note**

- You can specify the device name of this machine using **[Configuration] → [Basic Settings] → [General Settings] → [Device Name]**.
- If the specified directory does not exist in the FTP server, a directory is automatically created.

File Names

Files created by a Scan to FTP operation are named as described below in accordance with the file name you specified.

In case you did not specify a file name, the default file name “DOC” applies.

❖ **File names with time**

When **[File Name + Time]** (included under **[Configuration] → [File Send Settings] → [File Send]** on the Web Status Monitor) is set to “On”, file names are generated in the following manner.

“Specified file name/Year/Month/Day/Hour/Minute/Second/(4-digit sequential number)”

- Example 2:
 Specified file name: image
 File format: single page
 Original type: black white, text
 Pages: 2, two-sided
 Time when scanned: 2003/9/16/13:07:21
 The following files are generated:
 image030916130721(0001).TIF
 image030916130721(0002).TIF
 image030916130721(0003).TIF
 image030916130721(0004).TIF
- Example 3:
 Specified file name: (none)
 File format: multi-page TIFF
 Original type: colour, full colour
 Pages: 2, two-sided
 Time when scanned: 2003/9/16/13:07:21
 The following file is generated:
 DOC030916130721(0001).PDF

❖ File names without time

When **[File Name + Time]** (included under **[Configuration]** → **[File Send Settings]** → **[File Send]** on the Web Status Monitor) is set to “Off”, file names are generated in the following manner.

“Specified file name/(4-digit sequential number)”

- Example 4:
Specified file name: image
File format: single page
Original type: black white, text
Pages: 2, two-sided
Time when scanned: 2003/9/16 /13:07:21
The following files are generated:
image(0001).TIF
image(0002).TIF
image(0003).TIF
image(0004).TIF
- Example 5:
Specified file name: (none)
File format: multi-page TIFF
Original type: colour, full colour
Original page count: 2, two-sided
Time when scanned: 2003/9/16 /13:07:21
The following file is generated:
DOC(0001).PDF

🔍 Reference

For details about file formats and extensions, see p.73 “File Type”.

📝 Note

- ❑ All the files created in the examples 2 to 5 are saved to the same folder, which is explained in the example 1.
- ❑ When you send scan files to the folder that you have already sent scan files before, be sure to assign a different file name if **[File Name + Time]** is set to “Off”. If you specify the same file name and file type that you specified in the previous Send File operation, the previous scan files are overwritten with new ones.

9. Sending Scan Files Using Delivery Server

This chapter explains procedures to deliver a scanned file to multiple destinations by using a delivery server with ScanRouter V2 Professional/Lite installed.

Procedure Breakdown

The following overview diagram shows the flow of the steps for sending a scanned file using an address book on a delivery server. Note that the underlined steps are essential.

Note

- Some of the steps such as making scan settings are identical to those explained under "Sending Scan Files by E-mail". See the relevant pages shown to the right of the following overview diagram.

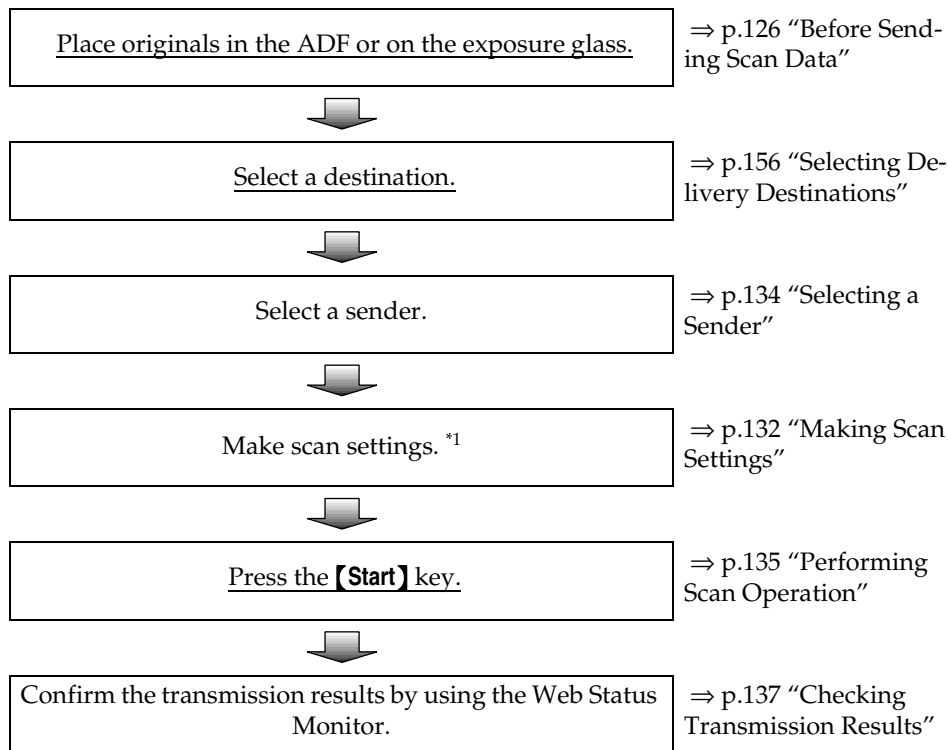

*1 The settings that are configured using ScanRouter V2 Professional/Lite determine the file type and compression method of the image file to be distributed.

Selecting Delivery Destinations

You can specify up to 100 destinations at a time, by selecting from the registered destinations in the address book of the delivery server.

1 Press the **[1]** key.

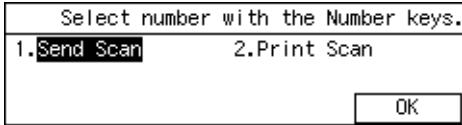

Note

- You can skip this step when the Delivery Server standby screen is displayed.

The Delivery Server standby screen is displayed.

2 Press **[Dest.]**.

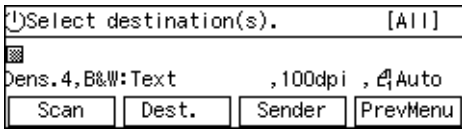

Note

- If " On " is selected for **[Auto Update Destination List]** in **[2.Send Scan Settings]** under the Scanner Features menu on this machine, the destination list is automatically updated with the delivery server's mail address book, when you press **[Dest.]**. See p.61 "Auto Update Destination List" for details.

The list of destinations registered to the delivery server appears.

3 Use **[Next]** and **[Prev.]** to scroll through the pages, and display the destination you want to select.

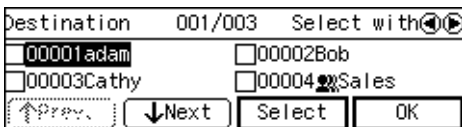

4 Use the **[▶]** and **[◀]** keys to highlight the destination you want to select, and then press **[Select]**.

This selects the check box next to the destination.

Note

- appears next to a group destination.

5 Repeat steps **3** and **4** for selecting each of the additional destinations.

Note

- While highlighting a destination with its check box selected, press **[Clear]** to clear the check box (this deselects the destination).

To recall destinations using a title

1 Press the **[./*]** (Title) key.

List of titles appears on the screen.

Note

- The titles that are configured using ScanRouter V2 Professional/Lite appear.

2 Use the **[▶]** or **[◀]** key to highlight the title you want to select, and then press **[OK]**.



The destinations assigned to the selected title are displayed.

Note

- ❑ You can select the title under which each of the registered destinations is assigned by using ScanRouter V2 Professional/Lite.

3 Highlight the destination you want to select, and then press [Select].

Note

- ❑ While highlighting a destination with its check box selected, press **[Clear]** to clear the check box (this deselects the destination).
- ❑ If you want to select from another title, press the **[/*]** (Title) key. This displays list of titles again.

6 When you are finished, press [Exit].

The Delivery Server standby screen appears. The first destination you have selected appears at the second line of the screen. When you have selected multiple destinations, you can confirm them by using the **[▶]** and **[◀]** keys.

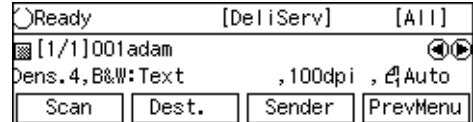

To recall all available destinations

1 Press the [/*] (Title) key.

List of titles appears on the screen.

2 Use the [▶] or [◀] key to highlight [All], and then press [OK].

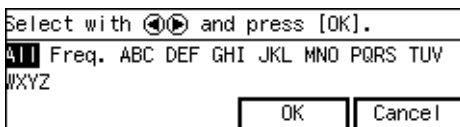

10. Printing Scanned Image Files

This chapter explains how to use "Print Scan" function, which enables you to print scan data directly by a printer.

Procedure Breakdown

The following overview diagram shows the flow of the steps for printing scan data using a registered printer.

Note that the underlined steps are essential.

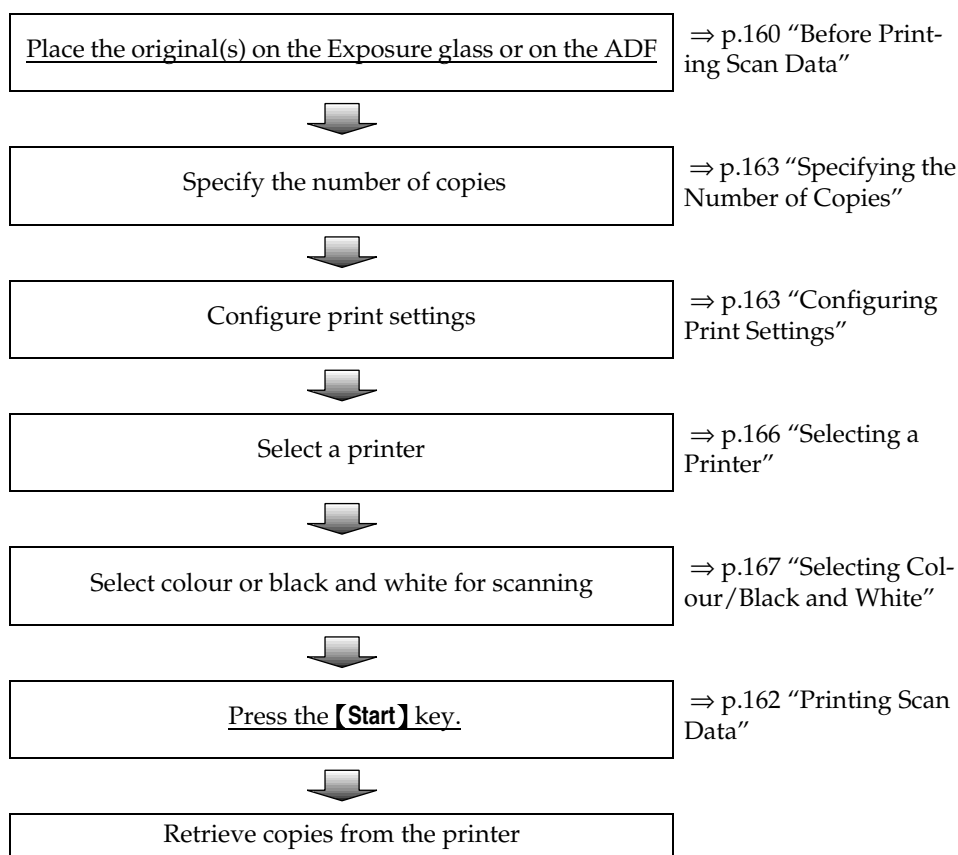

Before Printing Scan Data

Reference

See p.109 "Setting Originals" for information about how to place the originals on the ADF (Auto Document Feeder) or exposure glass, and about available paper size and weight.

Original Locations

When you perform a Print Scan operation, it is not necessary to select the location (ADF or exposure glass) for scanning. This machine automatically detects the originals placed on the ADF or the exposure glass, and scan is performed. Note, however, that the originals on the ADF are scanned when the originals are placed on both of the ADF and the exposure glass.

About Paper Tray Settings

You can specify a certain paper tray of a printer by selecting **[Configuration]** → **[Print Scan Settings]** → **[Printer]** → **[Paper Source Tray]** on the Web Status Monitor. By using the control panel of this machine, you can select a specific printer, but you cannot select a specific paper tray of a printer.

About Print Scan Standby Screen

Before performing a Print Scan operation, make sure that the Select Method screen or Print Scan initial screen is displayed on the machine's display panel.

- When the message " Select destination(s). " is displayed on the display panel, the machine is standing by for Send Scan. Press **[PrevMenu]** to return to the Select Method screen.

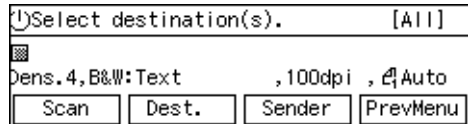

- When the message " Connecting with PC... " is displayed on the display panel, the machine is used from a client computer, and scanning is in progress. Wait until the job now in progress ends.

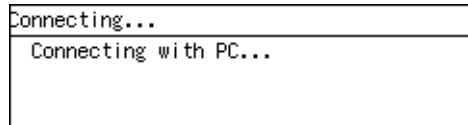

- When the message " Connecting with PC... Set original(s) and select the settings from the PC. " is displayed on the display panel, the machine is standing by for the network TWAIN. Press **[Exit]**.

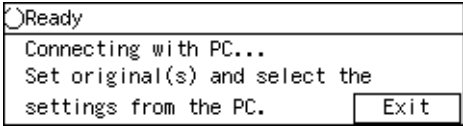

If there are no **[Exit]**, the Network TWAIN exclusive standby screen is displayed. In this case, restart the machine.

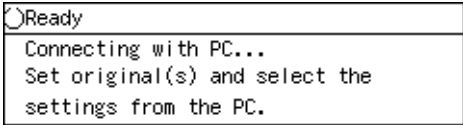

- When a send file path name is displayed at the second line of the screen, the standby screen for **[Enter Custom Send File]** is displayed. In this case, press **[PrevMenu]**.

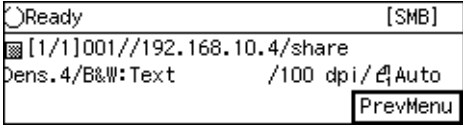

Printing Scan Data

Follow the steps below to print scan data using Print Scan.

1 Press the **[2]** key.

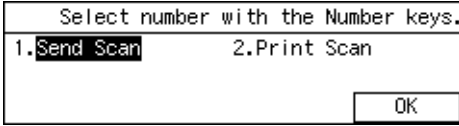

Note

- You can skip this step when the Print Scan standby screen is displayed. See p.19 “Standby screens” for information about the Print Scan standby screen.

The Print Scan standby screen is displayed.

2 Check if all the settings displayed on the screen (number of copies, printer, colour, and other print settings) are the way you want.

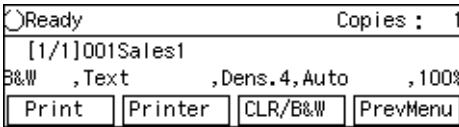

- **Number of copies**
The number of copies is displayed at the top right of the screen (default: 1). See p.163 “Specifying the Number of Copies” for details about changing the number of copies.
- **Printer**
The default printer is selected using **[Default Printer]** in **[Configuration]** → **[Print Scan Settings]** → **[Printer]** on the Web Status Monitor. For details, see Web Status Monitor Help.

- **Color/Black and White**
The default setting selected using **[Colour:Full Colour]** (in **[3.Print Scan Settings]** under the Scanner Features menu) is displayed at the left end of the third line of the screen. See p.167 “Selecting Colour/Black and White” for information about changing this setting.
- **Other print settings**
The default settings configured using **[Scan Type]**, **[Image Density]**, **[Original Size]**, and **[Reduce/Enlarge]** in **[5.Print Settings]** under the Scanner Features menu are displayed as the second to fifth items on the third line of the screen. See p.163 “Configuring Print Settings” to change these settings.

3 Press the **[Start]** key of this machine.

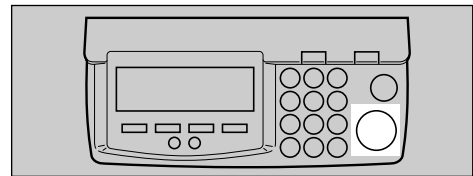

The original is scanned on this machine, and the scan data is printed using the selected printer.

Note

- If you want to cancel printing, press the **[Clear/Stop]** key.

The " Ready " message changes to " Printing... " .

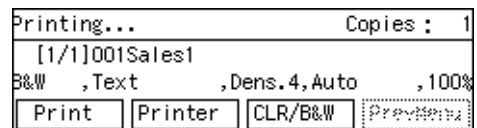

Note

- Do not turn the power of this machine off while  is displayed on the screen.

- If you want to continue print scan data by scanning the originals on the exposure glass, repeat step 2 and 3.

Specifying the Number of Copies

You can specify the number of copies within the range that you have configured using **[Max. Number of Copies]** in **[3.Print Scan Settings]** under the Scanner Features menu.

- While the Print Scan standby screen is displayed, enter the number of copies you want by using the number keys.

Ready	Copies : 1
[1/1]001Sales1	
B&W ,Text	,Dens.4,Auto ,100%
Print	Printer CLR/B&W PrevMenu

This returns to the Print Scan standby screen, and the number you have entered is displayed at the top right of the screen

Configuring Print Settings

When you perform a Print Scan operation, you can change the settings initially displayed on the screen (which settings are those that you have configured and registered to **[Default]** in **[5.Print Settings]** under the Scanner Features menu).

- While the Print Scan standby screen is displayed, press **[Print]**.

Ready	Copies : 1
[1/1]001Sales1	
B&W ,Text	,Dens.4,Auto ,100%
Print	Printer CLR/B&W PrevMenu

The Print Settings screen is displayed.

- Select whether you configure the print settings manually, or use one of the user settings you have registered.

Print Settings	Select with 
Manual	User 1 User 2 User 3
B&W ,Text	,Dens.4,Auto ,100%
Settings	Status OK Cancel

Reference

You can confirm the print settings you have registered. See p.165 "Confirming the Print Settings".

Note

- Press **[Cancel]** if you want to use the settings you have registered to **[Default]**.
- You cannot edit and save the settings that you have registered to **[User 1]**, **[User 2]** and **[User 3]** here. If you want to use one of the user settings while changing some of them, recall the user setting you want to use by highlighting it and pressing **[OK]** first. And then, change the settings by selecting **[Manual]**.

To recall a registered print settings

- 1 Use the **[▶]** or **[◀]** key to highlight **[User 1]**, **[User 2]** or **[User 3]** on the screen, and then press **[OK]**.

This returns to the Print Scan standby screen, and the corresponding print settings are displayed on the third line of the screen.

To configure print settings manually

- 1 Use the **[▶]** or **[◀]** key to highlight **[Manual]** on the screen, and then press **[Settings]**.

The first page of the Print Settings screen (Print Settings 1/2) is displayed.

- 2 Use the **[▶]** or **[◀]** key to highlight the setup items you want to change, and then press **[Settings]**.

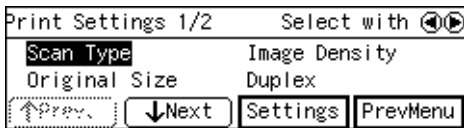

Reference

See p.79 “Information to Register in [Print Settings]” for details about each of the setup items.

- 3 Highlight the option you want to select by using the **[▶]** or **[◀]** keys (and **[Next]** or **[Prev.]** if necessary), and then press **[OK]**.

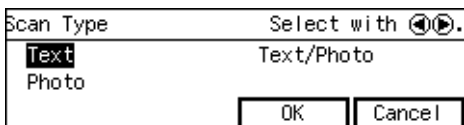

Note

- Pressing **[Cancel]** discards the selected option, and returns to the previous screen.
- When you select **[Custom Size]**, use the number keys to enter the dimensions of the scan area (width and height).

- 4 Repeat steps 2 and 3 as necessary.

When you are finished, make sure that the first page of the Print Settings screen (Print Settings 1/2) is displayed.

- 5 Press **[Next]**.

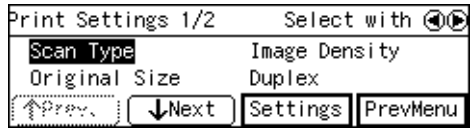

The second page of the Print Settings screen (Print Settings 2/2) is displayed.

- 6 Use the **[▶]** or **[◀]** key to highlight the setup items you want to change, and then press **[Settings]**.

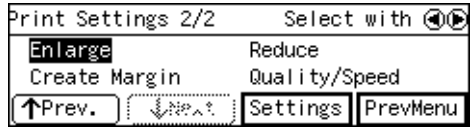

Note

- If you change the settings in **[Enlarge]**, **[Reduce]** and **[Create Margin]**, only the latest setting that you have selected within all of these setup items applies.

- 7 Highlight the option you want to select by using the **[▶]** or **[◀]** keys, and then press **[OK]**.

Note

- While the setting screen for **[Enlarge]** or **[Reduce]** is displayed, highlighting one of the preset ratio displays pairs of "original size → copy paper size" on the third line of the screen.

- If you want to set a custom ratio for **[Enlarge]** or **[Reduce]**, highlight the nearest preset ratio, press **[Zoom]**, and then use the number keys (or **[-]** and **[+]**) to specify the ratio.

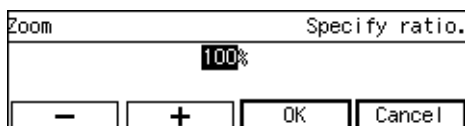

- Press **[OK]**.

This saves the ratio you have entered, and returns to the second page of the Print Settings screen (Print Settings 2/2).

Note

- Pressing **[Cancel]** discards the setting you have entered, and returns to the previous screen.

- When you are finished, press **[PrevMenu]**.

This returns to the Print Settings screen.

- Press **[OK]**.

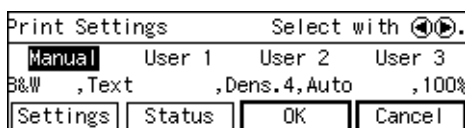

This returns to the Print Scan standby screen, and the print settings are displayed on the third line of the screen.

Confirming the Print Settings

You can confirm the current print settings, or the print settings that you have registered to **[Default]**, **[User 1]**, **[User 2]** or **[User 3]**.

Note

- You can confirm the **[Default]** settings by selecting **[Manual]** in step 2 below, unless you configure the print settings manually. After you have manually configured the print settings, selecting **[Manual]** displays the current settings.

- While the Print Scan standby screen is displayed, press **[Print]**.

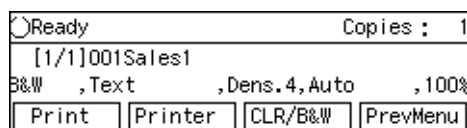

The Print Settings screen is displayed.

- Use the **[▶]** or **[◀]** key to highlight **[Manual]**, **[User 1]**, **[User 2]** or **[User 3]** on the screen, and then press **[Status]**.

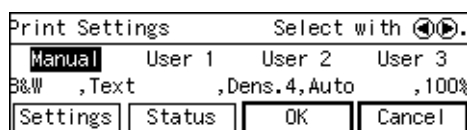

The status screen of your selection appears.

- Use **[Next]** and **[Prev.]** to display the setting of the setup item you want to confirm.

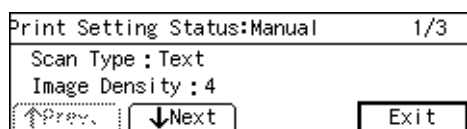

- When you are finished, press **[Exit]**.

5 Press **[Cancel]** or **[OK]**.

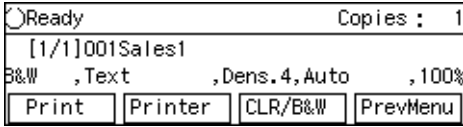

Note

- If you want to apply the print settings you selected in step 2, press **[OK]**. If you want to exit the status screen without changing anything, press **[Cancel]**.

This returns to the Print Scan standby screen.

Selecting a Printer

When you perform a Print Scan operation, you can select a printer other than the default printer (that is selected using **[Default Printer]** in **[Configuration]** → **[Print Scan Settings]** → **[Printer]** on the Web Status Monitor).

1 While the Print Scan standby screen is displayed, press **[Printer]**.

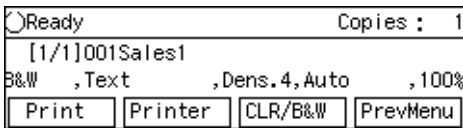

2 Highlight the printer you want to select by using the **[▶]** or **[◀]** keys (and **[Next]** or **[Prev.]** if necessary), and then press **[Select]**.

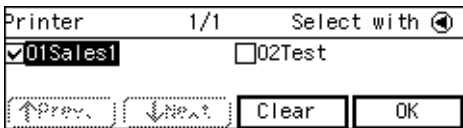

This selects the check box next to the printer name.

Note

- Selecting another printer automatically deselects the printer currently selected (so the check mark next to the printer is cleared).

- While highlighting a printer name with its check box selected, press **[Clear]** to clear the check box (this deselects the printer).

To recall printers using a title

1 Press the **[/*]** (Title) key.

List of titles appears on the screen.

Note

- Titles are displayed according to the settings in **[Configuration]** → **[Basic Settings]** → **[Scanner]** → **[Select Title]** on the Web Status Monitor.

2 Use the **[▶]** or **[◀]** key to highlight the title you want to select, and then press **[OK]**.

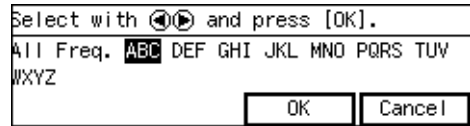

The printers assigned to the selected title are displayed.

Note

- You can select the title under which each of the registered printers is assigned in **[Configuration]** → **[Print Scan Settings]** → **[Printer]** → **[Assign Title]** on the Web Status Monitor.

3 Highlight the printer you want to select, and then press **[Select]**.

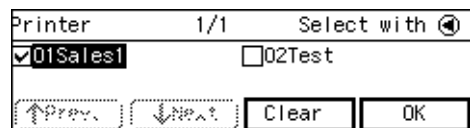

 **Note**

- ❑ While highlighting a printer name with its check box selected, press **[Clear]** to clear the check box (this deselects the printer).
- ❑ If you want to select from another title, press the **[./*]** (Title) key. This displays list of titles again.

To recall all available printers

1 Press the **[./*]** (Title) key.

List of titles appears on the screen.

2 Use the **[▶]** or **[◀]** key to highlight **[All]**, and then press **[OK]**.

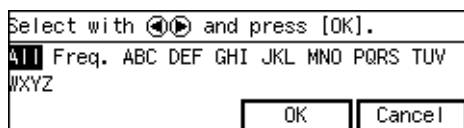

3 When you are finished, press **[Exit]**.

This returns to the Print Scan standby screen.

Selecting Colour/Black and White

When you perform a Print Scan operation, you can select between "colour" scanning and "black and white" scanning. If you do not select this setting, the default setting selected using **[Colour/Black and White]** (in **[3.Print Scan Settings]** under the Scanner Features menu) applies.

1 While the Print Scan standby screen is displayed, press **[CLR /B&W]**.

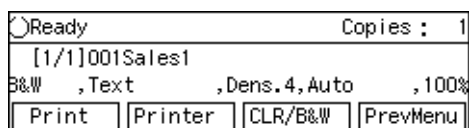

2 Use the **[▶]** or **[◀]** key to highlight **[Black and White]** or **[Colour]** on the screen.

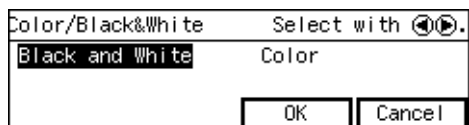

 **Note**

- ❑ When the above screen is displayed, currently selected option is highlighted.

3 While the option you want is highlighted, press **[OK]**.

This returns to the Print Scan standby screen.

 **Note**





- ❑ Pressing **[Cancel]** discards the selected option, and returns to the previous screen.

Troubleshooting

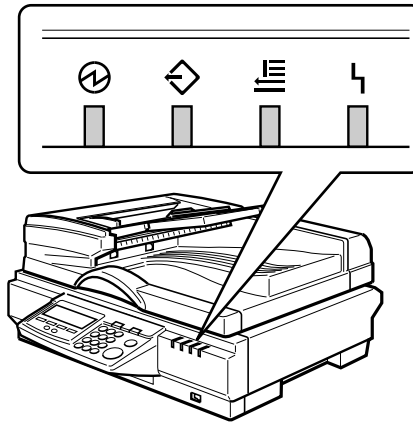
Error Indicators

The following table shows the meaning of error indicators of this machine, and how to fix the errors.



				Error description	Solution
◎	—	—	◎	The ADF or ADF cover is not fully closed.	Close the ADF or ADF cover.
◎	—	○	◎	An original is jammed in the ADF.	Removed the jammed original.
◎	—	◎	◎	An original was not output properly from the ADF.	Remove the paper that was not output properly.
○	○	○	○	System error	Contact your service representative.

◎: ON

○: Blinking

—: OFF

Note

- When the indicators show a status that is not listed the above table (or in the table under “Front indicators” ⇒ p.16), turn off the power of this machine, and then back on. If the indicators still show the same status, note the status of the indicators and contact your service representative.

When the Machine does not Work as Expected

When the original is jammed in the ADF, remove the original by the following procedure.

- 1** Open the ADF cover and remove if the original is jammed.

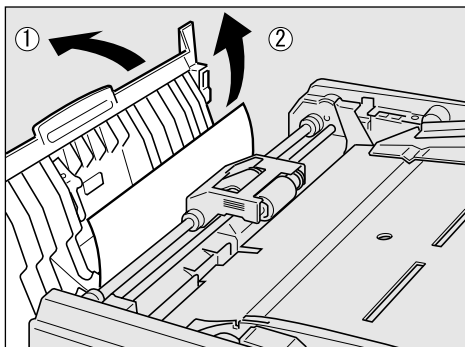

- 2** Open the original table and remove if the original is jammed.

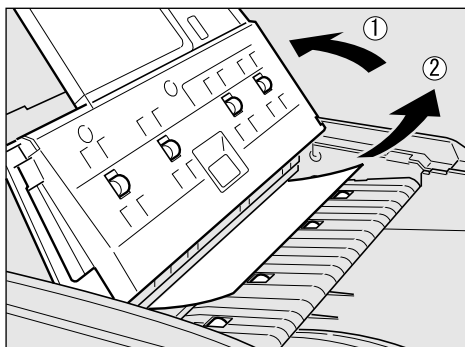

- 3** Open the ADF.

- 4** Lower the green tab and remove if the original is jammed.

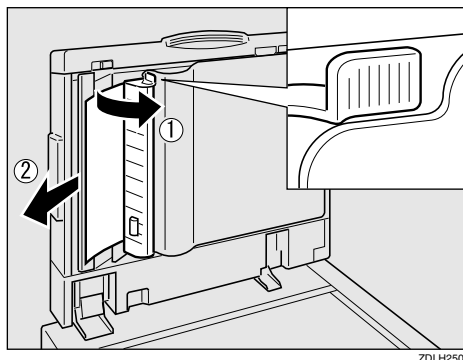

When Scanning is Not Performed as Expected

Condition	Possible Cause and Required Action
The scanned image is dirty.	<ul style="list-style-type: none"> Exposure glass, the ADF exposure glass, white sheet or original roller is dirty. Clean the exposure glass, the ADF exposure glass, white sheet, or original roller ⇒ p.180 "Cleaning"
Image is distorted or out of position.	<ul style="list-style-type: none"> The original was moved while scanning. Do not move the original while scanning. The original was not pressed flat against the exposure glass. Make sure that the original is pressed flat against the exposure glass.
The scanned image is upside down.	<ul style="list-style-type: none"> The original was placed upside down. Place the original in the correct orientation. ⇒ p.112 "Original Orientation"
No image results from scanning.	<ul style="list-style-type: none"> The original was placed with the front and back reversed. When the original is placed directly on the exposure glass, the side to be scanned must face down. When the original is fed via the ADF, the side to be scanned must face up.
The printer that you have specified for printing scanned data does not print after you perform a Print Scan operation.	<ul style="list-style-type: none"> If an error message is shown on the display of this machine, see p.172 "When an Error Message Appears" to eliminate the error. If no error message is displayed on this machine, it means an error has occurred on the printer, or the printer may not be configured properly. Confirm that the printer operates normally, and is properly configured. See the manual that comes with the printer.

When an Error Message Appears

When an error message appears, see the following lists of error messages to find possible causes of the error, and take the steps necessary to eliminate the cause of the error.

The lists are classified into several categories such as “Scanner Unit Error Messages”, “Scan Settings Error Messages” and “Send Scan Operation Error Messages”, making it easy for you to find the error you encounter.

This section includes all the error messages that are displayed on this machine, and also includes some of the error messages displayed on the Web Status Monitor.

 **Note**

- If an error message that is not contained in this section appears, turn off the power of this machine, and then back on. If the message still is shown, note the content of the message and the error number and contact your service representative.

 **Reference**

See the network TWAIN driver help when an error message appears on the client computer from which you use this machine as a network TWAIN scanner.

Scanner unit error message

Message	Possible Cause and Required Action
Cover Open Close ADF Cover. [Exit]	<ul style="list-style-type: none"> • The ADF cover is open. Close it.
Paper Misfeed Remove the original(s) in ADF. [Exit]	<ul style="list-style-type: none"> • Some pages are jammed in the ADF. Remove the jammed pages.
Functional Problems Turn operation switch off then on. If the same error occurs again, please call service.	<ul style="list-style-type: none"> • Confirm that the scanner is properly connected to the network. • When the machine is moved from a cold location to a warm location, sudden temperature changes cause condensation inside of the scanner. Wait one hour or more before turning on the scanner to allow the condensation to evaporate. • Restart the scanner. If the error appears again, note the contents of the error message and the error number, and contact a service centre. ("SC4xxx" is the error number. The number displayed differs according to the error type.)

Scan settings error messages

Message	Possible Cause and Required Action
<p>Cannot detect the scan size. Check whether the original is set, then select the proper size.</p> <p>[Exit]</p>	<p>The original is not on the exposure glass, or it is placed but the scan size cannot be automatically detected.</p> <ul style="list-style-type: none">• If the original is not there, place it on the exposure glass.• Because the scanner detects the scan size when the ADF is opened and closed, make sure you open the ADF to an angle of 30 degrees or more.• Small size paper and some paper sizes may not be detected automatically. For details, see p.110 "The Original Sizes Available for Auto Detection" .

Message	Possible Cause and Required Action
<p>Exceeded Job Delivery Data Max. Scanning will be stopped and the scanned data will be deleted. [Exit]</p>	<p>Scanning of the first original has failed.</p> <ul style="list-style-type: none"> • Confirm the setting in [4.Scan Settings] → [Scan Type]. If “ Colour&colon;Full Colour ” is selected, change to another option. “ Black and White&colon;Text ” is good for scanning most monochrome originals, and even “ Black and White&colon;Text/Photo ” is enough for scanning originals in 2 colors (e.g. an original containing text printed in black and charts drawn in red). • Confirm the setting in [4.Scan Settings] → [Resolution]. Specify a lower resolution, if the current setting is unnecessarily high. Normally, 200dpi or lower resolution setting is enough for scanning text. • Set [Compression (Black and White)] in [2.Send Scan Settings] to “ On ” when [Scan Type] in [4.Scan Settings] is set to one of the “ Black and White ” options. Set [Compression (Gray Scale/Full Colour)] in [2.Send Scan Settings] to an option that is higher than the current setting, when [Scan Type] in [4.Scan Settings] is set to one of the “ Colour ” options. • Make the value of the following settings larger using the Web Status Monitor: <ul style="list-style-type: none"> • [Configuration] → [E-mail Settings] → [E-mail] → [Max. E-mail Size] when sending scan data as an e-mail attachment • [Configuration] → [Delivery Settings] → [Delivery] → [Job Delivery Data Max. Setting] when sending scan data using a delivery server • [Configuration] → [File Send Settings] → [File Send] → [Job Delivery Data Max. Setting] when sending scan data to a Windows shared folder or an FTP server
<p>Exceeded Job Delivery Data Max. Send the current scanned data or delete to cancel this job. [Delete] [Send]</p>	<p>Scanning of the second or subsequent original has failed.</p> <ul style="list-style-type: none"> • To send the data up to the previous page scanned, press [Send]. After the ↩ mark on the screen disappears, press the [Start] key to scan the remaining pages. • If you press [Delete], scanned data is deleted and the document is not sent. Try scanning with such settings that make data size smaller, or perform scanning several times to create a number of separate files, each of which file size is small enough for a Send Scan operation.

Send Scan (E-mail, Send File (SMB/FTP) or Delivery Server) operation error messages

Message	Possible Cause and Required Action
<p>Updating the destination list...</p> <p>Please wait.</p>	<ul style="list-style-type: none"> When " On " is selected for [Auto Update Destination List] in [2.Send Scan Settings] on this machine, pressing [Dest.] accesses the sender and destination information from the delivery server, and updates the address book. This function allows you access the latest destination information. Depending on the number of destinations and senders registered, and the network conditions, you may have to wait a moment while the address book is being updated.
<p>Updating destination list failed. Do you want to try again?</p> <p>[Yes] [No]</p>	<p>Address book (list of destinations and senders) information could not be accessed on the delivery server. Click [Yes] and try again. If the same message appears, one of the following may have occurred.</p> <ul style="list-style-type: none"> The delivery server is not turned on, or it is not being serviced. The delivery server is temporarily down for reasons such as insufficient memory.
<p>Cannot communicate with the server. Check the server status and connection.</p> <p>[Exit]</p>	<ul style="list-style-type: none"> If you specified to perform a Scan to Folder (SMB) operation, check if the power of the computer on which the Windows shared folder exists is turned on. If you specified to perform a Send Scan operation using a delivery server, check if the delivery server is turned on. If you specified to perform a [Enter Custom Send File] operation using the Web Status Monitor, click [Back] on the Web browser, enter [Login Password], and then click [Test]. If the message "Connection to the File Send Path has failed. Confirm the settings." is displayed, [File Send Path] is not specified correctly.
<p>Sending data has failed. Scan with the same settings and re-send.</p> <p>[Exit]</p>	<ul style="list-style-type: none"> The machine failed to send scanned data due to a network connection problem. After confirming that the network cable is properly connected, try performing another Send Scan operation using the same settings.If the same message appears, there may be network congestion. Consult your network administrator.

Message	Possible Cause and Required Action
Exceeded max. scan pages. To scan remaining pages as a new job, press [Exit] then press the Start key. [Exit]	<ul style="list-style-type: none"> Continued scanning and reached the maximum scan limit (100 pages). Press [Exit]. The scanned original is sent. The specified destination and scanning condition settings remain the same even after you have pressed [Exit]. Place the next original and press the [Start] key.

Print Scan operation error messages



Message	Possible Cause and Required Action
Printer is offline. Check the printer. [Exit]	<ul style="list-style-type: none"> The printer you have selected for printing is currently offline. Press the [Online] key on the printer to make it online. Press [Exit] to start printing.
The printer is currently in use. Cannot print. [Exit]	<ul style="list-style-type: none"> The printer is currently in use. Press [Exit] to cancel the print job (this discards the scan data), and try again later.
Selected printer is not supported. Check the printer. [Exit]	<ul style="list-style-type: none"> The printer is not compatible with this machine. Select other printer that is supported for use with this machine.
No response from the device. Check the power and cables. [Exit]	<ul style="list-style-type: none"> The printer is not responding. Check if the power of the printer is turned on, and the cables are connected correctly.
Warming up... Check the printer. [Exit]	<ul style="list-style-type: none"> The printer is not ready to print, because it is still warming up. Wait until the printer is ready.
Add paper to the printer. [Exit]	<ul style="list-style-type: none"> Take the necessary actions in accordance with the message that is displayed. See the manual that comes with the printer for information about adding paper, replacing toner bottle, closing the cover of the printer, or clearing misfeeds.
Add Toner Replace Toner Bottle in the printer. [Exit]	
Cover Open Check the printer. [Exit]	
Paper Misfeed Check the printer. [Exit]	
Functional Problems Check the printer. [Exit]	
Functional Problems Check the printer. [Exit]	<ul style="list-style-type: none"> The printer has functional problems other than those mentioned above. Check to make sure that the printer operates normally. See the manual that comes with the printer.

Error messages displayed on the Web Status Monitor

Message	Possible Cause and Required Action
Wrong parameter for Login User Name.	<ul style="list-style-type: none"> The format for entering [Login User Name] is incorrect. Confirm that [Login User Name] is specified in the format of "work group name\user name" or "domain name\user name". For example, when the work group name is "abcd" and the user name is "john", enter "abcd\john" into [Login User Name].
Wrong parameter for File Send Path Name.	<ul style="list-style-type: none"> The information entered to [File Send Path], [Login User Name], or [Login Password] is incorrect. When entering information, be careful not to mix up upper case letters and lower case letters. In most cases, it is required to enter the password into [Login Password] for the user entered in [Login User Name]. However, when accessing a shared folder that is password protected under Windows 95/98/98 SE/Me, it is necessary to enter the shared folder's protection password into [Login Password]. Confirm the operating system of the computer that you are trying to access, and make necessary settings in accordance with it, as described the above.
Unable to make configurations because Scanner is currently in use. Please try again later.	<ul style="list-style-type: none"> This machine is currently used as a network TWAIN scanner, by another client computer. You may be trying another [Enter Custom Send File] operation. Before performing another [Enter Custom Send File] operation, it is necessary to press [PrevMenu] on the control panel of this machine to display a Send File standby screen.

Other Problems

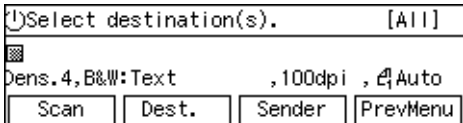
Problem	Possible Cause and Required Action
<p>Two or more units of this machine with the same (or similar) device name exist on the same network.</p>	<ul style="list-style-type: none"> You can change the device name of this machine from [Configuration] → [Basic Settings] → [General Settings] → [Device Name] on the Web Status Monitor. The factory default for the device name is "RNP*****" ("*****" is the last six digit of the machine's MAC address). When you change the device name, note that you cannot change to a name that starts with "RNP".
<p>Cannot login to this machine using a Web browser.</p>	<ul style="list-style-type: none"> Check the display panel of this machine. When the Scanner Features menu is displayed, it becomes unavailable to access this machine using a Web browser. Press [Exit] or the [User Tools] key to return to a standby screen. See p.21 "Scanner Features Menu" Check if the IP address of this machine is correctly configured, in accordance with the assignment of the network that this machine belongs. When configured incorrectly, it is not possible to access this machine using a Web browser. You can confirm the IP address of this machine using [IP Address] in [1.System Settings] under Scanner Features menu. If the IP address of this machine is set to "11.22.33.44", it means that you haven't configured this machine yet, or all the settings of this machine have returned to their default values for some reasons. In this case, you have to configure all the necessary settings including the IP address and scan settings, etc. When you use this machine on a DHCP environment, and when the IP address of this machine is allocated dynamically, the machine's IP address changes each time this machine turns on. Under this condition, it is necessary for you to check the current IP address of this machine, and then enter the address to a Web browser from which you access this machine. (It makes no sense to add the current address to favorite, because it changes each time this machine turns on.) If it is possible, we recommend you to assign an IP address of this machine statistically, even when you use this machine on a DHCP environment. You still have to select "DHCP" for [Network Boot] in [1.System Settings] to have the IP address of this machine allocated automatically.
<p>No response from the display panel when it is touched.</p>	<ul style="list-style-type: none"> The display panel of this machine is not a touch panel. To use keys displayed on the screen, press the function keys. See p.15 "Using Keys Displayed on the Screen" .
<p>Entered information or selected option is cleared while operating.</p>	<ul style="list-style-type: none"> Auto Reset Timer is activated. After a specified period of the last operation, this machine automatically returns to the state immediately after power-on. You can change the time after which the Auto Reset Timer works, or even disable it. See p.59 "Auto Reset Timer" .

Problem	Possible Cause and Required Action
<p>This machine does not work in accordance with the scan settings configured on the Web Status Monitor.</p>	<ul style="list-style-type: none"> After configuring the scan settings (specifically, after clicking [OK] on the [Scan Settings] screen) on the Web Status Monitor, press the [Clear Modes] key. By pressing the [Clear Modes] key, the settings under [Scan Settings] of this machine instantly reflect the settings configured using the Web Status Monitor.
<p>Some of the registered destinations are not displayed on the destination list.</p>	<ul style="list-style-type: none"> Check if [All] is displayed at the top right corner of the "Select destination(s)." screen.  <p>If another title like [A], [B] or [Freq.] is on the screen, it means that you have searched destinations using the [J*] (Title) key, and only the matched destinations are currently available for selection. In this case, press the [J*] (Title) key, highlight [All], and then press [OK]. See p.129 "To recall all available destinations" for details.</p>
<p>The e-mail destinations (including Cc destinations) are cleared when a file name is specified.</p>	<p>When you perform a Send Scan operation, note the following things.</p> <ul style="list-style-type: none"> You cannot use the following functions at the same time: <ul style="list-style-type: none"> Scan to E-mail (referred to as "e-mail function" here) Scan to Folder (SMB) (referred to as "SMB function" here) Scan to FTP (referred to as "FTP function" here)  <p>When you select [File Name] and then press [Settings] on the screen shown above, it means that you select either of the SMB or FTP function, and the e-mail function is disabled. Because of this, the e-mail destinations are cleared automatically. Specifying [To&colon;], [Cc&colon;], or [Subject] disables the SMB or FTP function. Specifying [SMB] disables the e-mail and FTP function. Specifying [FTP] disables the e-mail and SMB function.</p>

Cleaning

⚠ **WARNING:**

- Never remove any covers or screws other than those specified in this manual. The inside of the scanner contains high-voltage components that can cause electrical shock. Have all inspections, adjustments, and repairs inside the scanner performed by an authorized dealer only.
- Do not attempt to modify this scanner in any way. Modification can cause fire or electrical shock.

⚠ **CAUTION:**

- When disconnecting the power cord, always make sure to hold onto the plug. Do not pull on the power cord itself. This can cause damage to the cord, fire or electrical shock.

We recommend periodically cleaning the scanner to ensure that it is in optimum operating condition. First, wipe off the scanner with a dry, soft cloth. Next, dampen a soft cloth with water, wring it out tightly, and then wipe off the scanner. Use a neutral detergent for exterior portions of the scanner where soiling cannot be removed with water alone. Wipe off the rubber rollers with ethyl alcohol, and then wipe with a cloth dampened with water. Finally, wipe off the rollers and exterior with a dry cloth to remove any excess moisture.

⚠ **Important**

- ❑ Do not use volatile chemicals such as benzene, paint thinner or spray with insecticides. This can cause deformation, discoloration and cracking.
- ❑ Wipe off the Automatic Document Feeder (ADF) with a dry, clean cloth when there is dust or soiling present inside.

Cleaning the Exposure Glass, ADF Exposure Glass, White Sheet, and White Plate

⚠ **CAUTION:**

- Be careful not to pinch your fingers when closing the Automatic Document Feeder (ADF).

- 1** Turn off the power of the scanner and unplug the power cord from the outlet.
- 2** Wipe off the scanner with a dry, soft cloth.

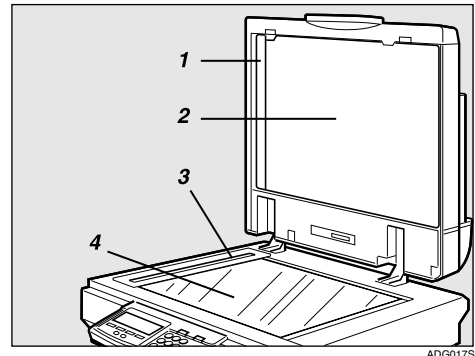

- 1. White Plate**
- 2. White Sheet**
- 3. ADF Exposure Glass**
- 4. Exposure Glass**

Cleaning the Feed Roller

- 1** Turn off the power of the scanner and unplug the power cord from the outlet.
- 2** Open the cover of the Automatic Document Feeder (ADF).

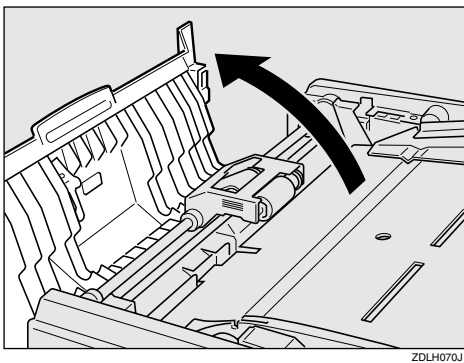

- 3** Open the roller unit. While turning it with your fingers, wipe off the Feed Roller with a tightly wrung out cloth dampened with water.

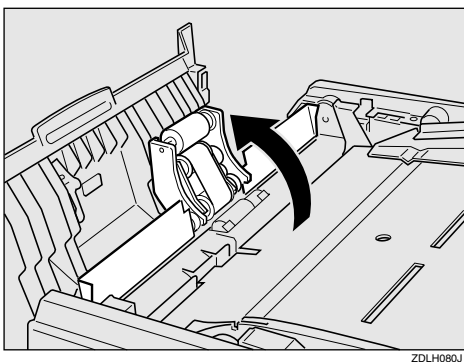

Note

- Always make sure to clean the Feed Roller after scanning a document written in pencil or other material that is not firmly fixed to the paper. Failure to clean the Feed Roller can cause soiling of the next document scanned.

Cleaning the Document Roller

- 1** Turn off the power of the scanner and unplug the power cord from the outlet.
- 2** Open the cover of the Automatic Document Feeder (ADF).

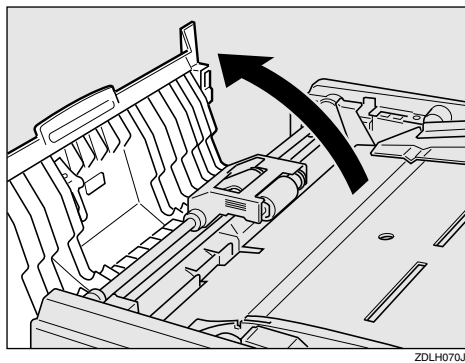

- 3** While turning it with your fingers, wipe off the Document Roller (①) with a tightly wrung out cloth dampened with water.

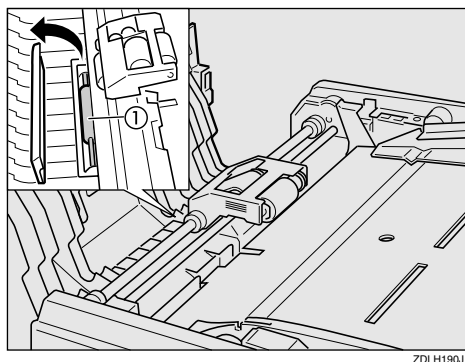

Cleaning the Document Rolling Unit

- 1** Turn off the power of the scanner and unplug the power cord from the outlet.
- 2** Open the cover of the Automatic Document Feeder (ADF).

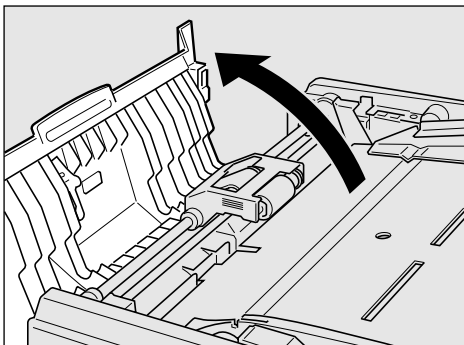

ZDLH070J

- 3** Open the Document Tray and wipe off the Document Rolling Unit with a tightly wrung out cloth dampened with water.

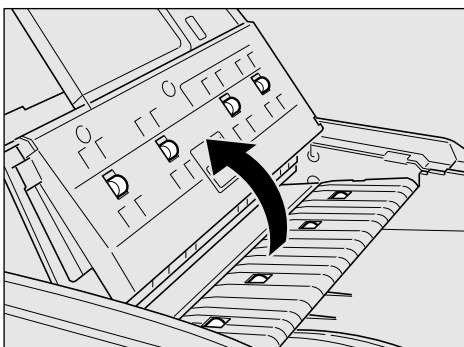

ZDLH090J

Moving and Transporting the Scanner

⚠ CAUTION:

- This scanner weighs approximately 29 kg.
 - When lifting, please make sure to lift slowly so as to minimize physical strain with two persons or more while holding onto the handles located in the center on both sides. Failure to lift using proper caution, reckless handling or allowing the scanner to drop can cause injury.
 - When transporting over long distances, please consult an authorized dealer.
- Safety laws and regulations (including those stipulating radio wave regulations and material regulations) differ in each country. Use of this product and its consumable supplies, etc. in foreign countries in violation of these regulations may be punishable by law.
 - Information regarding measures for ensuring safe transport can be obtained from an authorized dealer. However, packaging and transport are to be performed by the customer.

Moving Over Short Distance

- 1** Turn off the power of the scanner and unplug the power cord from the outlet.
- 2** Disconnect all cables connected to the scanner.
- 3** Transport the scanner.

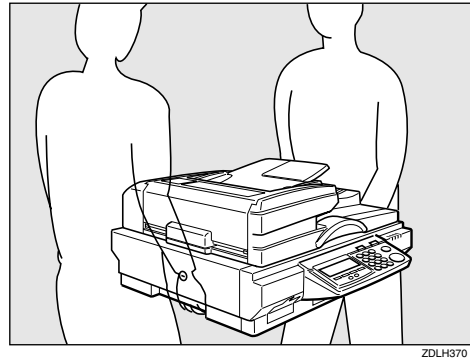

⚠ Important

- ❑ Try to keep the scanner as level as possible during transport.

Transporting the Scanner

- 1** Turn on the Power Switch. Allow the scanner to remain on for at least 20 seconds, and then turn it off.
- 2** Set the Lock Switch on the left side of the scanner to the **[Lock]** position.

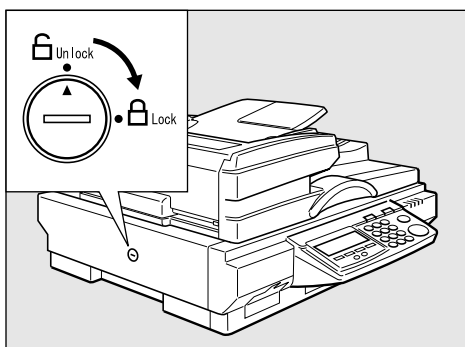

ZDLH380

- 3** Remove the control panel unit from the scanner unit, and disconnect all cables connected to the scanner.
- 4** Place the scanner in the original box and transport.

Important

- This scanner is a precision device. Be careful so that it is not damaged during transport.
- Use the cushioning materials provided with the scanner at the time of purchase.

Disposing of the Scanner

When you want to dispose of your scanner, contact your dealer or a service representative.

Important

- ❑ Never dispose of the lithium batteries by incineration. This can cause them to rupture resulting in injury.

Note

- ❑ Please return used NIC boards to our authorized dealer or service representative. Your cooperation with our recycling activities is appreciated.
- ❑ NIC boards are equipped with a lithium battery. In the case NIC boards are disposed of by the customer, please dispose them in accordance with national or local regulations after separating the lithium batteries from the NIC board.

Using Wireless LAN

This section describes the setting procedure related to network when the optional "Expansion wireless LAN board type BII" is used

Preparation

Prepare a 10BASE-T or 100BASE-TX cross network cable beforehand. When you use a network device as a hub, prepare a 10BASE-T or 100BASE-TX straight network cable.

Outline to Use Wireless LAN

You can configure settings for a wireless LAN card using [Configuration] → [Basic Settings] → [TCP/IP] on the Web Status Monitor. Before getting started, it is necessary to prepare for logging in the Web Status Monitor.

Make preparations to log in to the web status monitor.

Connect this machine and a computer using a network cable temporarily

Sample setting for this machine:
 IP Address : 192.168.1.2
 Subnet Mask : 255.255.255.0

Sample setting for the computer:
 IP Address : 192.168.1.3
 Subnet Mask : 255.255.255.0



Use the Web Status Monitor to configure the wireless LAN settings.

Configuring Wireless LAN Settings

Preparation

It is necessary to change the network settings of the computer that you use for configuring wireless LAN settings. Be sure to note your computer's network settings before you change them, for reference when you restore the settings afterwards.

- 1 Connect a computer to this machine.

When you use a cross network cable

- 1 Connect a cross network cable to the network interface connector of this machine.

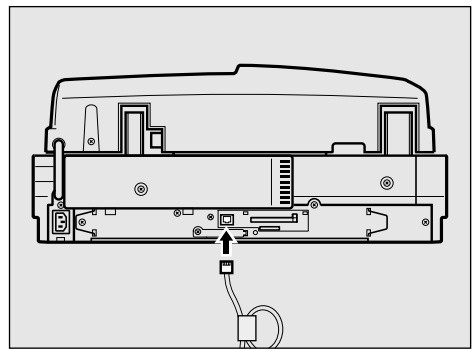

- 2 Connect the other end of the cable to the computer.

When you use a hub

- 1 Connect a straight network cable to the network interface connector of this machine.

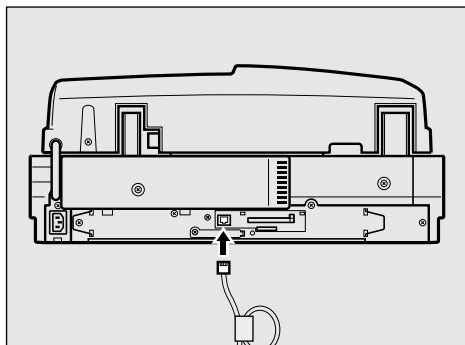

ADG004S

- 2 Connect the other end of the cable to an available connector of the hub.
- 3 Confirm that the computer is connected to the hub ②.

When not connected, connect the computer to the hub using a 10BASE-T or 100BASE-TX straight network cable.

- 2 Change the computer's IP address to 192.168.1.3, and subnet mask to 255.255.255.0.

- 3 Restart the computer.

The computer's IP address is changed to 192.168.1.3.

- 4 Press the **[User Tools]** key on this machine.

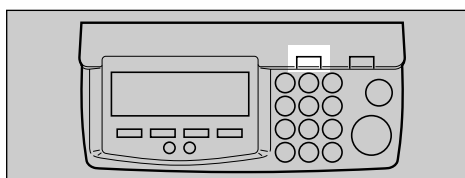

ABK006S

The scanner Features menu appears.

- 5 Press the **[1]** key.

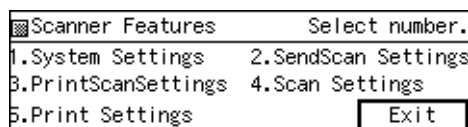

The System Settings menu is displayed, and "1. Function Priority" appears as the setup item currently selected.

- 6 Press **[Next]**.

"1. IP Address" input screen will appear.

"2. IP Address" appears as the setup item currently selected.

- 7 Press **[OK]**.

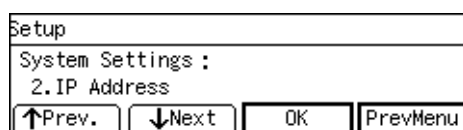

- 8 Enter "192.168.1.2" with the number keys.

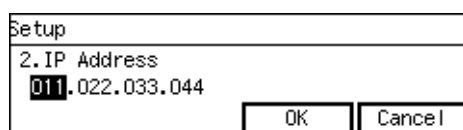

Note

- ❑ Input each part of the IP address in three digits.
- ❑ You can use **[▶]** (or **[#]**) and **[◀]** keys to move the highlighting to right and left.
- ❑ You can use the **[Clear/Stop]** key to clear the three-digit number currently highlighted.

- 9 Press **[OK]**.

This returns to the System Settings menu.

- 10 Press **[↓Next]**.

"3. Subnet Mask" appears as the setup item currently selected.

- 11** Set [Subnet Mask] to 255.255.255.0 in the same way as you have done in steps **7** through **10**.

“4. Default Gateway Address ” appears as the setup item currently selected.

- 12** Press [Next] three times, and then press [OK].

The setting screen for “7. Network Boot ” appears.

- 13** Confirm that [7. Network Boot] is set to “ NONE ”, and press [Cancel].

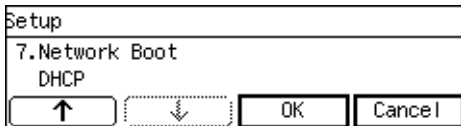

Note

- “*” mark appears along with the option currently selected.
- If [7.Network Boot] is set to “ DHCP ”, change it to “ NONE ”, and then press [OK].

- 14** Confirm that [10.Transmission Speed] is set to “ Auto ” and [11.LAN Type] is set to “ Ethernet ”, in the same way that you have done for [7.Network Boot].

- 15** Press [PrevMenu], and then [Exit].

This exits the Scanner Features menu, and returns to the standby screen that is displayed when you turn the power on.

Important

- Never turn off the power of this machine before the standby screen is displayed. Doing so can discard all the settings you have configured, and return this machine to its factory default status.

- 16** Turn off the power of this machine, Insert the wireless LAN card to the PC Card slot on the rear panel, and then attach the card slot cover.

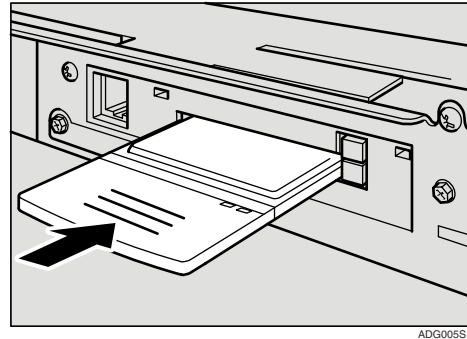

Reference

⇒ p.29 “Inserting a Wireless LAN Card”

- 17** Turn ON the power of this machine.

- 18** Start a Web browser on the computer, and enter “http://192.168.1.2 /” in the address bar.

Reference

For details about the Web Status Monitor, see p.84 “Accessing the Scanner”.

- 19** Click [Configuration] on the main menu.

The password input dialog box appears.

Note

- Once you set the password, the password input dialog box will not appear from the second time. When the dialog doesn’t appear, proceed to step **21**.

20 Enter “scanner” for the user name, enter the password, and then click [OK].

 **Note**

- User name is fixed to “scanner”.
- The initial factory default password is “password”. You can change the password using [Configuration] → [Basic Settings] → [Password].

The setup screen appears.

21 Click [Basic Settings], and then [TCP/IP] on the sub-menu.

22 Make settings to each of the setup items on the screen.

 **Reference**

⇒ p.52 “System Settings”

❖ **LAN Type**

Switch between network interface board and wireless LAN (IEEE 802.11b) board. Be sure to set this item to “IEEE 802.11b”.

❖ **Network Boot**

Select [DHCP] to use the DHCP server to make network settings automatically. When using DHCP, the IP address, subnet mask, and default gateway address obtained from the DHCP server are used.

Select [NONE] to make network settings manually.

❖ **Communication Mode**

Select the communication mode.

- **Infrastructure mode**
A method of communicating with other computers via an access point. The SSID must be the same as the one set for the access point.

- **Ad hoc mode**
A method of communicating with other computers, peer to peer, without an access point. The same communication channel must be used for all computers.
- **802.11 Ad hoc mode**
A method of communicating with other computers, peer to peer, without an access point. The same communication channel and SSID must be used for all computers.

❖ **SSID**

Enter the SSID (Service Set Identifier) you want to use, using up to 32 characters. The SSID currently in use appears in parentheses.

This information appears if [802.11 Ad hoc mode] or [Infrastructure mode] is selected in the [Communication Mode] list.

The SSID is an identifier used when connecting between an access point and a wireless LAN client. Only a wireless LAN client and an access point that have the same SSID can communicate with each other.

❖ **Channel**

If [802.11 Ad hoc mode] or [Ad hoc mode] is selected in the [Communication Mode] list, select a communication channel.

The channel is a set radio frequency used for wireless LAN (IEEE 802.11b). Computers using the same channel can communicate with each other.

❖ **WEP Setting**

Select whether to enable or disable WEP (Wired Equivalent Privacy) encryption.

WEP encryption protects wireless data communication. To communicate using WEP, data from both transmitting and receiving computers must be set with the same WEP Key. To enable WEP encryption, select **[Enable]** in the list, and then enter the WEP key in the **[WEP Key]** box.

❖ **WEP Key and Confirm WEP Key**

The same WEP key must be entered in **[WEP Key]** and **[Confirm WEP Key]** boxes.

- 64 bit Key
When **[Enable]** is selected in the **[WEP Setting]** list, enter a 10-digit hexadecimal WEP key value in **[WEP Key]** and **[Confirm WEP Key]** boxes. Enter the WEP key value without the prefix "0x". The value entered appears as "*".
- 128 bit Key
When **[Enable]** is selected in the **[WEP Setting]** list, enter a 26-digit hexadecimal WEP key value in **[WEP Key]** and **[Confirm WEP Key]** boxes. A 128-bit key provides higher security than a 64-bit key. Enter the WEP key value without the prefix "0x". The value entered appears as "*".

23 Click **[Apply]** to apply the settings.

The set value will be written into this product.

24 Remove the cable you connected in step **1**.**25** Restore the network settings on the computer.**26** Turn off the power of this machine, and then back on to activate the settings. **Note**

- When you change the **[LAN Type]** setting and/or change the **[Network Boot]** setting from "NONE" to "DHCP", it is essential to restart this machine to activate the changes.
- In infrastructure mode, signal strength of the wireless LAN appears as a percentage at the Web Status Monitor's **[Wireless LAN Signal]** (that is included under **[Configuration]** → **[Basic Settings]** → **[TCP/IP]**), or **[Wireless LAN Signal]** in **[1.System Settings]** under Scanner Features menu on this machine. The following list provides an indication of the signal strength of the wireless LAN. Note, however, that the wireless LAN connection may fail due to noise or other reasons, even when **[Wireless LAN Signal]** displays a percentage that falls "Good" in the following list.
 - 100~76% : Best
 - 75~41% : Good
 - 40~21% : Poor
 - 20~0% : Communication impossible

E-mail Address Book Data Format and Device Tag Information

This section describes the data format of CSV files that are exported by selecting **[Entered Program Information]** and **[Device Tag Information]** using the Web Status Monitor. Read this section when you create or edit a CSV file for updating the address book of this machine.

Reference

For information about the procedures, see p.89 “To export the address data to a CSV file”.

Entered Program Information

The following table shows example contents of a CSV file that is exported from the address book (e-mail destination list) of this machine using the Web Status Monitor. You can use a CSV file created in this format, to update the address book data of this machine.

Line 1	#Entered Program Information
Line 2	#Format Version:3.1.1.0
Line 3	#Obtained Date:16/04/2004 07:35:36
Line 4	#Device Name:RNP7983AD
Line 5	#Address:192.168.0.133
Line 6	#Program No.,Type,Name,Displayed Name,Freq.,Title 1,Title 2,Title 3,E-mail,Sender,Password,User Code, Assigned Group
Line 7	[00001], [A], [Sam], [Sam], [1], [1], [6], [1], [Sam@company.com], [1], [], [], []
Line 8	[00002], [A], [Janei], [Jane], [1], [1], [4], [1], [Jane@company.com], [1], [], [], []

Note

- Lines 1 through 6 contain information obtained from this machine. When you want to update the address book of this machine using a CSV file, use an exported CSV file and edit it, while leaving these lines as they are.
- Line 7 and subsequent lines include e-mail address information. For details, see “About the e-mail address information” below.
- The default name of a CSV file that is exported using **[Entered Program Information]** is “<device name>_addr.csv”. When the <device name> of this machine is set to “RNP625C65”, for example, the default file name becomes “RNP625C65_addr.csv”.

About the e-mail address information

The following example shows a set of values that constitute an e-mail address record. When you edit a CSV file for updating the address book data of this machine, insert a line that is formatted in the following way per an e-mail address record into the file.

Example of an e-mail address record:

```
[00015], [A], [Edward], [Edward], [0], [1], [2], [3], [Edward@abcdefg.com], [1], [TExMTA==], [] []
```

❖ **[00015] : Program No.**

Indicates the number for the e-mail address.

❖ **[A] : Type**

The value of this item is fixed to "A". "A" indicates the e-mail address type is "user".

❖ **[Edward] : Name**

Indicates the e-mail address owner (user) name.

❖ **[Edward] : Key Display**

Indicates the name to appear on the control panel.

❖ **[0] : Frequently Used Title(s)**

Determines whether the e-mail address information is to be registered to the [Freq.] title.

[0] : Registered [1] : Not registered

❖ **[1] : Title1**

This item is used only when you select "Japanese" as the display language of this machine.

❖ **[2] : Alphabet (Title2)**

Determines under which alphabetical title this e-mail address record belongs to.

Title2 Convention:

ABC=1,DEF=2,GHI=3,JLK=4,MNO=5,PQRS=6,TUV=7,WXYZ=8

For example, [2] indicates "DEF" is selected for the alphabetical title of this record.

❖ **[3] : Custom Title (Title3)**

Determines under which Custom Title this e-mail address record belongs to.

Title3 Convention:

1=1,2=2,3=3,4=4,5=5

For example, [3] indicates "03" is selected for the Custom Title of this record.

❖ **[Edward@abcdefg.com] : E-mail Address**

Indicates the destination's e-mail address.

❖ **[1] : Register as Sender**

Determines whether the e-mail address is used not only as the destination but as the sender also.

[0] : Not used as sender [1] : Used as sender

❖ **[TExMTA==] : Protected Password**

When an e-mail address record in the exported CSV file from this machine is password protected, the encrypted password appears like the one shown above.

 **Note**

- When you update the address book of this machine using a CSV file, create the file with its password entries are all left blank. You can set a sender's password for each of the e-mail addresses after you have imported the CSV file, by selecting an e-mail address and clicking **[Change]** button inside the **[E-mail Address]** screen (which you can display from **[Configuration]** → **[E-mail Settings]** → **[E-mail Address]**) on the Web Status Monitor.

 **Note**

- The last two items (shown as “ [], [] ” in the example) are fixed to blank for this machine.

Device Tag Information

The following table shows an example of the Device Tag Information, which contains the title information of this machine. You can export the Device Tag Information to a CSV file using the Web Status Monitor.

Line 1	#Device Tag Information
Line 2	#Obtained Date:16/04/2004 07:36:14
Line 3	#Device Name:RNP7983AD
Line 4	#Address:192.168.0.133
Line 5	#Program Frequently Used Title(s),Off=0,On=1,
Line 6	Program Title 1,,
Line 7	Program Title 2,ABC=1,DEF=2,GHI=3,JKL=4,MNO=5,PQRS=6,TUV=7,WXYZ=8,
Line 8	Program Title 3,1=1,2=2,3=3,4=4,5=5,

 **Note**

- You can use the Device Tag Information file only for your reference. It cannot be imported to this machine.
- The default name of a CSV file that is exported using **[Device Tag Information]** is “<device name>_taginfo.csv”.

How File Size Changes Depending on Scan Area and Resolution

Scan area and resolution determine the file size of a scanned data. The following general rules apply:

- Doubling the scan area doubles the file size.
- Doubling the resolution (dpi) quadruples the file size.
- Setting higher resolution makes available scan area smaller, while setting larger scan area lowers available resolution.

When Using this Machine as a Network TWAIN Scanner

The following tables show file sizes in accordance with the scan area and resolution settings, when scanning is performed by using this machine as a network TWAIN scanner.

 **Note**

- ❑ In the following tables, each of the values inside of white cells display the data size in KB, determined by the scan area to the left and the resolution at the top.
- ❑ The following tables show file sizes without compression.
- ❑ Actual file sizes may vary depending on the file type setting (single page, PDF or multi-page TIFF).
- ❑ A “-” in a cell means that the combination of the relevant settings is not available.
- ❑ Even when a file size is shown in a cell, it may happen that you cannot perform a scanning operation with the relevant settings due to the limitation of the TWAIN-compliant application you use for scanning. For information about the maximum file size that the application can handle, see the manual that comes with the application.

When [Binary] or [Halftone] is selected

Scan Area			Resolution (dpi)						
Paper Size	Width (mm)	Height (mm)	100	200	400	600	1200	2000	2400
A3	297	420	236	943	3772	8487	33968	94398	135942
A4	210	297	118	470	1886	4247	16991	47181	67969
A5	148	210	58	234	940	2117	8468	23511	33870
A6	105	148	29	117	469	1058	4233	11755	16935
B4	257	364	176	705	2827	6365	25475	70785	101948
B5	182	257	88	354	1415	3183	12734	35393	50972
B6	128	182	43	175	703	1583	6339	17619	25386
11×17	279	432	242	970	3880	8729	34938	97096	139823
Legal (8 1/2 x 14)	216	356	145	580	2327	5231	20940	58170	83800
Letter (8 1/2 x 11)	216	279	114	455	1823	4099	16412	45588	65676
5 1/2 x 8 1/2	140	216	56	227	913	2058	8231	22870	32955
—	297	2000	1123	4491	17963	40416	161755	—	—

When [Gray-scale] is selected

Scan Area			Resolution (dpi)						
Paper Size	Width (mm)	Height (mm)	100	200	400	600	1200	2000	2400
A3	297	420	1887	7551	30209	67965	—	—	—
A4	210	297	943	3774	15104	33979	135939	—	—
A5	148	210	469	1881	7525	16934	67742	188166	—
A6	105	148	235	940	3761	8467	33868	94077	135484
B4	257	364	1415	5662	22654	50967	20883	—	—
B5	182	257	707	2831	11327	25483	101942	—	—
B6	128	182	352	1409	5640	12691	50774	141033	203094
11×17	279	432	1941	7765	31072	69903	—	—	—
Legal (8 1/2 x 14)	216	356	1163	4653	18619	41897	167589	—	—
Letter (8 1/2 x 11)	216	279	911	3646	14590	32834	131347	—	—
5 1/2 x 8 1/2	140	216	457	1829	7320	16477	65907	183074	—

When [8 colors] or [8 colors (halftone)] is selected

Scan Area			Resolution (dpi)						
Paper Size	Width (mm)	Height (mm)	100	200	400	600	1200	2000	2400
A3	297	420	943	3775	15101	33977	135929	—	—
A4	210	297	471	1886	7550	16989	67963	188793	—
A5	148	210	235	939	3762	8467	33871	94075	135484
A6	105	148	117	470	1879	4233	16934	47033	67735
B4	257	364	707	2830	11324	25483	101933	—	—
B5	182	257	353	1415	5663	12739	50971	141593	203892
B6	128	182	176	704	2818	6344	25383	70516	101547
11×17	279	432	970	3883	15533	34947	139814	—	—
Legal (8 1/2 x 14)	216	356	581	2327	9307	20949	83794	—	—
Letter (8 1/2 x 11)	216	279	456	1823	7293	16417	65673	182416	—
5 1/2 x 8 1/2	140	216	228	915	3660	8236	32954	91529	131821

When [256 colors] is selected

Scan Area			Resolution (dpi)						
Paper Size	Width (mm)	Height (mm)	100	200	400	600	1200	2000	2400
A3	297	420	1887	7551	30209	67965	—	—	—
A4	210	297	943	3774	15104	33979	—	—	—
A5	148	210	469	1881	7525	16934	67742	—	—
A6	105	148	235	940	3761	8467	33868	—	—
B4	257	364	1415	5662	22654	50967	—	—	—
B5	182	257	707	2831	11327	25483	—	—	—
B6	128	182	352	1409	5640	12691	50774	—	—
11×17	279	432	1941	7765	31072	69903	—	—	—
Legal (8 1/2 x 14)	216	356	1163	4653	18619	41897	—	—	—
Letter (8 1/2 x 11)	216	279	911	3646	14590	32834	65907	—	—
5 1/2 x 8 1/2	140	216	457	1829	7320	16477	—	—	—

When [16770K colors] is selected

Scan Area			Resolution (dpi)						
Paper Size	Width (mm)	Height (mm)	100	200	400	600	1200	2000	2400
A3	297	420	5661	22652	90626	203894	—	—	—
A4	210	297	2829	11322	45313	101937	—	—	—
A5	148	210	1408	5642	22574	50801	203225	—	—
A6	105	148	704	2819	11284	25401	101603	—	—
B4	257	364	4244	16986	67961	152900	—	—	—
B5	182	257	2121	8493	33981	76450	—	—	—
B6	128	182	1055	4228	16919	38074	152321	—	—
11×17	279	432	5822	23296	93216	209710	—	—	—
Legal (8 1/2 x 14)	216	356	3489	13960	55857	125692	—	—	—
Letter (8 1/2 x 11)	216	279	2734	10937	43771	98502	—	—	—
5 1/2 x 8 1/2	140	216	1372	5488	21960	49431	197722	—	—

When Using this Machine for Sending Scan Data

The following tables show file sizes in accordance with the scan area and resolution settings, when scanning is performed using Scan to E-mail, Scan to File (SMB/FTP), or the delivery server function.

 **Note**

- In the following tables, each of the values inside of white cells display the data size in KB, determined by the scan area to the left and the resolution at the top.
- The following tables show file sizes without compression.
- Actual file sizes may vary depending on the file type setting (single page, PDF or multi-page TIFF).
- A “×” in a cell means that the combination of the relevant settings is not available.
- A “—” in a cell means that the combination of the relevant settings is available only when you perform scanning with a compression setting.

When [Black and White: Text], [Black and White: Text/Photo] or [Black and White: Photo] is selected

Scan Area			Resolution (dpi)				
Paper Size	Width (mm)	Height (mm)	100	200	400	600	1200
A3	297	420	236	944	3773	8488	×
A4	210	297	118	471	1887	4248	×
A5	148	210	59	235	940	2117	8468
B4	257	364	177	706	2828	6365	×
B5	182	257	89	354	1416	3184	×
11×17	279	432	228	914	3653	8218	×
Legal (8½x14)	216	356	146	580	2325	5226	×
Letter (8½x11)	216	279	115	456	1827	4106	×
5 ½ x 8 ½	140	216	57	228	914	2053	8218

When [Black and White: Gray Scale] is selected

Scan Area			Resolution (dpi)				
Paper Size	Width (mm)	Height (mm)	100	200	400	600	1200
A3	297	420	1888	7551	30209	—	×
A4	210	297	944	3775	15105	33980	×
A5	148	210	470	1881	7525	16934	—
B4	257	364	1416	5663	22654	50967	×
B5	182	257	708	2832	11328	25484	×
11×17	279	432	1827	7305	29219	—	×
Legal (8½x14)	216	356	1163	4649	18594	41837	×
Letter (8½x11)	216	279	914	3653	14610	32872	×
5 ½ x 8 ½	140	216	457	1827	7305	16436	—

When [Color: Full Color] is selected

Scan Area			Resolution (dpi)				
Paper Size	Width (mm)	Height (mm)	100	200	400	600	1200
A3	297	420	5662	22652	—	—	×
A4	210	297	2830	11323	45314	—	×
A5	148	210	1409	5643	22575	50802	—
B4	257	364	4245	16987	—	—	×
B5	182	257	2121	8494	33981	—	×
11×17	279	432	5479	21915	—	—	×
Legal (8½x14)	216	356	3487	13946	55782	—	×
Letter (8½x11)	216	279	2740	10958	43829	—	×
5 ½ x 8 ½	140	216	1370	5479	21915	49307	—

Options

❖ **Function Expansion Board**

- **Image Processing Unit Type A**
Enables highly advanced image processing such as automatic 2-value conversion processing and automatic image area separation.

❖ **Special Table**

- **Table Type 7100**
Provides comfortable installation of this machine.

❖ **Wireless LAN Card**

- **802.11b Interface Unit Type B A**
Provides wireless connection to a network. This card is enabled by inserting into the PC Card slot on the rear panel of this machine.

Specifications

Type:	Desktop flatbed colour scanner	
Scanning method	Fixed document scanning and moving document scanning	
Scanning area	<ul style="list-style-type: none"> Exposure Glass Main direction : 300mm (11.8") Max. Sub-direction : 432mm (17.0") Max. 	<ul style="list-style-type: none"> ADF Main direction: 297mm (11.7") Max. Sub-direction: 2000mm (78.7") Max. (when scanning in binary) 630mm (24.8") Max. (when scanning in colour or gray scale)
Resolution	Main scanning: 600dpi Sub scanning: 600dpi	
Scanning grade	Input: 12 bit per colour/pixel Output: 8 bit per colour/pixel	
Colour	Output: RGB, sRGB	
Scanning time	Binary: 0.605msec/line Colour: 1.815msec/line	
Interface	Network connection	Ethernet interface × 1 (10BASE-T or 100BASE-TX)
	Function expansion	Type II PC card slot × 1 (One of the slots is used exclusively for the USB interface card (USB 2.0) that comes with this machine.), SD card slot × 1
Control	Display panel	240 × 64 pixels, STN liquid crystal (4-line monochrome display)
	Operation keys	Number keys, 4 function keys, cursor keys (left/right), Start, Clear/Stop, Scanner Features, Reset, #, *
	Display language	Japanese, English, German, French, Spanish, Portuguese, Dutch, Italian
Memory	RAM: 128MB (64 MB is used for image processing)	
Self diagnosis function	Automatically turns the power off and back on, when a system freeze of the machine has occurred.	
Main features	<ul style="list-style-type: none"> Supports network TWAIN driver Scan to Print Scan to E-mail Scan to Folder (SMB) Scan to FTP Delivery Server 	
Life of flatbed	5 years	

Operating environment	Temperature: 10-32 °C (50-89.6 °F), humidity 15-80%
Power	220-240V, 50/60Hz 1A
Power consumption	During operation: 140W During standby: 60W During Low Power mode: 12W
Warm-up time	Max. 40 seconds
Transition time to the low power mode	About 15 minutes after the last operation or the end of the last scan job
Dimensions	590x647x265mm (23.2"x25.5"x10.4")(WxDxH) (including the ADF and control panel)
Weight	Approximately 29kg (63.9lb)

Software Information

GPL/LGPL Application Software

The software included in this product is software applying GPL/LGPL.

Customers who use or purchase this product have rights to obtain, modify or redistribute the source code for the applicable software. If you wish to obtain the GPL/LGPL application source code used in this product, please access <http://www.rioh.com/support/linux/>.

BSD License Application Software

This product includes software developed by the University of California, Berkeley and its contributors.

Copyright (c) 1985, 1989, 1990 The Regents of the University of California.

All rights reserved.

Redistribution and use in source and binary forms, with or without modification, are permitted provided that the following conditions are met:

1. Redistributions of source code must retain the above copyright notice, this list of conditions and the following disclaimer.
2. Redistributions in binary form must reproduce the above copyright notice, this list of conditions and the following disclaimer in the documentation and/or other materials provided with the distribution.

3. All advertising materials mentioning features or use of this software must display the following acknowledgement:

This product includes software developed by the University of California, Berkeley and its contributors.

4. Neither the name of the University nor the names of its contributors may be used to endorse or promote products derived from this software without specific prior written permission.

THIS SOFTWARE IS PROVIDED BY THE REGENTS AND CONTRIBUTORS "AS IS" AND ANY EXPRESS OR IMPLIED WARRANTIES, INCLUDING, BUT NOT LIMITED TO, THE IMPLIED WARRANTIES OF MERCHANTABILITY AND FITNESS FOR A PARTICULAR PURPOSE ARE DISCLAIMED. IN NO EVENT SHALL THE REGENTS OR CONTRIBUTORS BE LIABLE FOR ANY DIRECT, INDIRECT, INCIDENTAL, SPECIAL, EXEMPLARY, OR CONSEQUENTIAL DAMAGES (INCLUDING, BUT NOT LIMITED TO, PROCUREMENT OF SUBSTITUTE GOODS OR SERVICES; LOSS OF USE, DATA, OR PROFITS; OR BUSINESS INTERRUPTION) HOWEVER CAUSED AND ON ANY THEORY OF LIABILITY, WHETHER IN CONTRACT, STRICT LIABILITY, OR TORT (INCLUDING NEGLIGENCE OR OTHERWISE) ARISING IN ANY WAY OUT OF THE USE OF THIS SOFTWARE, EVEN IF ADVISED OF THE POSSIBILITY OF SUCH DAMAGE.

The Apache Software License Application Software

This product includes software developed by the Apache Software Foundation (<http://www.apache.org/>).

The Apache Software License, Version 1.1

Copyright (c) 2000 The Apache Software Foundation. All rights reserved.

Redistribution and use in source and binary forms, with or without modification, are permitted provided that the following conditions are met:

1. Redistributions of source code must retain the above copyright notice, this list of conditions and the following disclaimer.
2. Redistributions in binary form must reproduce the above copyright notice, this list of conditions and the following disclaimer in the documentation and/or other materials provided with the distribution.
3. The end-user documentation included with the redistribution, if any, must include the following acknowledgment:

"This product includes software developed by the Apache Software Foundation (<http://www.apache.org/>)."

Alternately, this acknowledgment may appear in the software itself, if and wherever such third-party acknowledgments normally appear.

4. The names "Apache" and "Apache Software Foundation" must not be used to endorse or promote products derived from this software without prior written permission. For written permission, please contact apache@apache.org.
5. Products derived from this software may not be called "Apache", nor may "Apache" appear in their name, without prior written permission of the Apache Software Foundation.

THIS SOFTWARE IS PROVIDED "AS IS" AND ANY EXPRESSED OR IMPLIED WARRANTIES, INCLUDING, BUT NOT LIMITED TO, THE IMPLIED WARRANTIES OF MERCHANTABILITY AND FITNESS FOR A PARTICULAR PURPOSE ARE DISCLAIMED. IN NO EVENT SHALL THE APACHE SOFTWARE FOUNDATION OR ITS CONTRIBUTORS BE LIABLE FOR ANY DIRECT, INDIRECT, INCIDENTAL, SPECIAL, EXEMPLARY, OR CONSEQUENTIAL DAMAGES (INCLUDING, BUT NOT LIMITED TO, PROCUREMENT OF SUBSTITUTE GOODS OR SERVICES; LOSS OF USE, DATA, OR PROFITS; OR BUSINESS INTERRUPTION) HOWEVER CAUSED AND ON ANY THEORY OF LIABILITY, WHETHER IN CONTRACT, STRICT LIABILITY, OR TORT (INCLUDING NEGLIGENCE OR OTHERWISE) ARISING IN ANY WAY OUT OF THE USE OF THIS SOFTWARE, EVEN IF ADVISED OF THE POSSIBILITY OF SUCH DAMAGE.

JPEG Software

This software is based in part on the work of the Independent JPEG Group.

In plain English:

1. We don't promise that this software works. (But if you find any bugs, please let us know!)
2. You can use this software for whatever you want. You don't have to pay us.
3. You may not pretend that you wrote this software. If you use it in a program, you must acknowledge somewhere in your documentation that you've used the IJG code.

In legalese:

The authors make **NO WARRANTY** or representation, either express or implied, with respect to this software, its quality, accuracy, merchantability, or fitness for a particular purpose. This software is provided "AS IS", and you, its user, assume the entire risk as to its quality and accuracy.

This software is copyright (C) 1991-1998, Thomas G. Lane.

All Rights Reserved except as specified below.

Permission is hereby granted to use, copy, modify, and distribute this software (or portions thereof) for any purpose, without fee, subject to these conditions:

- (1) If any part of the source code for this software is distributed, then this README file must be included, with this copyright and no-warranty notice unaltered; and any additions, deletions, or changes to the original files must be clearly indicated in accompanying documentation.

- (2) If only executable code is distributed, then the accompanying documentation must state that "this software is based in part on the work of the Independent JPEG Group".
- (3) Permission for use of this software is granted only if the user accepts full responsibility for any undesirable consequences; the authors accept **NO LIABILITY** for damages of any kind.

These conditions apply to any software derived from or based on the IJG code, not just to the unmodified library. If you use our work, you ought to acknowledge us.

Permission is **NOT** granted for the use of any IJG author's name or company name in advertising or publicity relating to this software or products derived from it. This software may be referred to only as "the Independent JPEG Group's software".

We specifically permit and encourage the use of this software as the basis of commercial products, provided that all warranty or liability claims are assumed by the product vendor.

ansi2knr.c is included in this distribution by permission of L. Peter Deutsch, sole proprietor of its copyright holder, Aladdin Enterprises of Menlo Park, CA. ansi2knr.c is **NOT** covered by the above copyright and conditions, but instead by the usual distribution terms of the Free Software Foundation; principally, that you must include source code if you redistribute it. (See the file ansi2knr.c for full details.) However, since ansi2knr.c is not needed as part of any program generated from the IJG code, this does not limit you more than the foregoing paragraphs do.

The Unix configuration script "configure" was produced with GNU Autoconf. It is copyright by the Free Software Foundation but is freely distributable. The same holds for its supporting scripts (config.guess, config.sub, ltconfig, ltmain.sh). Another support script, install-sh, is copyright by M. I. T. but is also freely distributable.

It appears that the arithmetic coding option of the JPEG spec is covered by patents owned by IBM, AT&T, and Mitsubishi. Hence arithmetic coding cannot legally be used without obtaining one or more licenses. For this reason, support for arithmetic coding has been removed from the free JPEG software. (Since arithmetic coding provides only a marginal gain over the unpatented Huffman mode, it is unlikely that very many implementations will support it.) So far as we are aware, there are no patent restrictions on the remaining code.

The IJG distribution formerly included code to read and write GIF files. To avoid entanglement with the Unisys LZW patent, GIF reading support has been removed altogether, and the GIF writer has been simplified to produce "uncompressed GIFs". This technique does not use the LZW algorithm; the resulting GIF files are larger than usual, but are readable by all standard GIF decoders.

We are required to state that

"The Graphics Interchange Format(c) is the Copyright property of CompuServe Incorporated. GIF(sm) is a Service Mark property of CompuServe Incorporated."

TIFF Software

Copyright (c) 1988-1997 Sam Leffler

Copyright (c) 1991-1997 Silicon Graphics, Inc.

Permission to use, copy, modify, distribute, and sell this software and its documentation for any purpose is hereby granted without fee, provided that (i) the above copyright notices and this permission notice appear in all copies of the software and related documentation, and (ii) the names of Sam Leffler and Silicon Graphics may not be used in any advertising or publicity relating to the software without the specific, prior written permission of Sam Leffler and Silicon Graphics.

THE SOFTWARE IS PROVIDED "AS-IS" AND WITHOUT WARRANTY OF ANY KIND, EXPRESS, IMPLIED OR OTHERWISE, INCLUDING WITHOUT LIMITATION, ANY WARRANTY OF MERCHANTABILITY OR FITNESS FOR A PARTICULAR PURPOSE.

IN NO EVENT SHALL SAM LEFFLER OR SILICON GRAPHICS BE LIABLE FOR ANY SPECIAL, INCIDENTAL, INDIRECT OR CONSEQUENTIAL DAMAGES OF ANY KIND, OR ANY DAMAGES WHATSOEVER RESULTING FROM LOSS OF USE, DATA OR PROFITS, WHETHER OR NOT ADVISED OF THE POSSIBILITY OF DAMAGE, AND ON ANY THEORY OF LIABILITY, ARISING OUT OF OR IN CONNECTION WITH THE USE OR PERFORMANCE OF THIS SOFTWARE.

UCD-SNMP Software

-- Part 1: CMU/UCD copyright notice: (BSD like) --

Copyright 1989, 1991, 1992 by Carnegie Mellon University

Derivative Work - 1996, 1998-2000

Copyright 1996, 1998-2000 The Regents of the University of California

All Rights Reserved

Permission to use, copy, modify and distribute this software and its documentation for any purpose and without fee is hereby granted, provided that the above copyright notice appears in all copies and that both that copyright notice and this permission notice appear in supporting documentation, and that the name of CMU and The Regents of the University of California not be used in advertising or publicity pertaining to distribution of the software without specific written permission.

CMU AND THE REGENTS OF THE UNIVERSITY OF CALIFORNIA DISCLAIM ALL WARRANTIES WITH REGARD TO THIS SOFTWARE, INCLUDING ALL IMPLIED WARRANTIES OF MERCHANTABILITY AND FITNESS. IN NO EVENT SHALL CMU OR THE REGENTS OF THE UNIVERSITY OF CALIFORNIA BE LIABLE FOR ANY SPECIAL, INDIRECT OR CONSEQUENTIAL DAMAGES OR ANY DAMAGES WHATSOEVER RESULTING FROM THE LOSS OF USE, DATA OR PROFITS, WHETHER IN AN ACTION OF CONTRACT, NEGLIGENCE OR OTHER TORTIOUS ACTION, ARISING OUT OF OR IN CONNECTION WITH THE USE OR PERFORMANCE OF THIS SOFTWARE.

-- Part 2: Networks Associates Technology, Inc copyright notice (BSD) --

Copyright © 2001, Networks Associates Technology, Inc

All rights reserved.

Redistribution and use in source and binary forms, with or without modification, are permitted provided that the following conditions are met:

- Redistributions of source code must retain the above copyright notice, this list of conditions and the following disclaimer.
- Redistributions in binary form must reproduce the above copyright notice, this list of conditions and the following disclaimer in the documentation and/or other materials provided with the distribution.
- Neither the name of the NAI Labs nor the names of its contributors may be used to endorse or promote products derived from this software without specific prior written permission.

THIS SOFTWARE IS PROVIDED BY THE COPYRIGHT HOLDERS AND CONTRIBUTORS "AS IS" AND ANY EXPRESS OR IMPLIED WARRANTIES, INCLUDING, BUT NOT LIMITED TO, THE IMPLIED WARRANTIES OF MERCHANTABILITY AND FITNESS FOR A PARTICULAR PURPOSE ARE DISCLAIMED. IN NO EVENT SHALL THE COPYRIGHT HOLDERS OR CONTRIBUTORS BE LIABLE FOR ANY DIRECT, INDIRECT, INCIDENTAL, SPECIAL, EXEMPLARY, OR CONSEQUENTIAL DAMAGES (INCLUDING, BUT NOT LIMITED TO, PROCUREMENT OF SUBSTITUTE GOODS OR SERVICES; LOSS OF USE, DATA, OR PROFITS; OR BUSINESS INTERRUPTION) HOWEVER CAUSED AND ON ANY THEORY OF LIABILITY, WHETHER IN CONTRACT, STRICT LIABILITY, OR TORT (INCLUDING NEGLIGENCE OR OTHERWISE) ARISING IN ANY WAY OUT OF THE USE OF THIS SOFTWARE, EVEN IF ADVISED OF THE POSSIBILITY OF SUCH DAMAGE.

-- Part 3: Cambridge Broadband Ltd. copyright notice (BSD) --

Portions of this code are copyright © 2001, Cambridge Broadband Ltd..

All rights reserved.

Redistribution and use in source and binary forms, with or without modification, are permitted provided that the following conditions are met:

- Redistributions of source code must retain the above copyright notice, this list of conditions and the following disclaimer.
- Redistributions in binary form must reproduce the above copyright notice, this list of conditions and the following disclaimer in the documentation and/or other materials provided with the distribution.

- The name of Cambridge Broadband Ltd. may not be used to endorse or promote products derived from this software without specific prior written permission.

THIS SOFTWARE IS PROVIDED BY THE COPYRIGHT HOLDER "AS IS" AND ANY EXPRESS OR IMPLIED WARRANTIES, INCLUDING, BUT NOT LIMITED TO, THE IMPLIED WARRANTIES OF MERCHANTABILITY AND FITNESS FOR A PARTICULAR PURPOSE ARE DISCLAIMED. IN NO EVENT SHALL THE COPYRIGHT HOLDER BE LIABLE FOR ANY DIRECT, INDIRECT, INCIDENTAL, SPECIAL, EXEMPLARY, OR CONSEQUENTIAL DAMAGES (INCLUDING, BUT NOT LIMITED TO, PROCUREMENT OF SUBSTITUTE GOODS OR SERVICES; LOSS OF USE, DATA, OR PROFITS; OR BUSINESS INTERRUPTION) HOWEVER CAUSED AND ON ANY THEORY OF LIABILITY, WHETHER IN CONTRACT, STRICT LIABILITY, OR TORT (INCLUDING NEGLIGENCE OR OTHERWISE) ARISING IN ANY WAY OUT OF THE USE OF THIS SOFTWARE, EVEN IF ADVISED OF THE POSSIBILITY OF SUCH DAMAGE.

MD5 Software License Agreement

Copyright (C) 1991-2, RSA Data Security, Inc. Created 1991. All rights reserved.

License to copy and use this software is granted provided that it is identified as the "RSA Data Security, Inc. MD5 Message-Digest Algorithm" in all material mentioning or referencing this software or this function.

License is also granted to make and use derivative works provided that such works are identified as "derived from the RSA Data Security, Inc. MD5 Message-Digest Algorithm" in all material mentioning or referencing the derived work.

RSA Data Security, Inc. makes no representations concerning either the merchantability of this software or the suitability of this software for any particular purpose. It is provided "as is" without express or implied warranty of any kind.

These notices must be retained in any copies of any part of this documentation and/or software.

Expat

Copyright © 1998, 1999, 2000 Thai Open Source Software Center Ltd. and Clark Cooper

Copyright © 2001, 2002 Expat maintainers.

Permission is hereby granted, free of charge, to any person obtaining a copy of this software and associated documentation files (the "Software"), to deal in the Software without restriction, including without limitation the rights to use, copy, modify, merge, publish, distribute, sublicense, and/or sell copies of the Software, and to permit persons to whom the Software is furnished to do so, subject to the following conditions:

The above copyright notice and this permission notice shall be included in all copies or substantial portions of the Software.

THE SOFTWARE IS PROVIDED "AS IS", WITHOUT WARRANTY OF ANY KIND, EXPRESS OR IMPLIED, INCLUDING BUT NOT LIMITED TO THE WARRANTIES OF MERCHANTABILITY, FITNESS FOR A PARTICULAR PURPOSE AND NONINFRINGEMENT. IN NO EVENT SHALL THE AUTHORS OR COPYRIGHT HOLDERS BE LIABLE FOR ANY CLAIM, DAMAGES OR OTHER LIABILITY, WHETHER IN AN ACTION OF CONTRACT, TORT OR OTHERWISE, ARISING FROM, OUT OF OR IN CONNECTION WITH THE SOFTWARE OR THE USE OR OTHER DEALINGS IN THE SOFTWARE.

INDEX

A

ADF, 13
Apache License, 206

B

BSD License, 205

C

Caution, 2
Checking Transmission Results, 137

E

E-mail
 Procedure Breakdown, 123
E-mail content, 124

F

File Names
 Sending scanned image files (FTP), 152
 Sending scanned image files (SMB), 147
File names without time, 148, 153
File names with time, 147, 152

J

JPEG License, 207

M

Making Scan Settings, 132

O

Operating Instructions, 4
Original location, 126
Original Orientation and Scanning Sides, 126

P

Performing Scan Operation, 135
Printing to the image, 122

Q

Quick Installation Guide, 4

S

Scanned Image Files Sent to FTP Servers, 152
Scanned Image Files Sent to
 Shared Folders, 147
Scanning Mode Registration, 122
Scanning Originals, 120
Selecting a File Name, 142
Selecting an FTP Server, 150
Selecting an SMB, 140
Selecting a Sender, 134
Selecting a Shared Folder, 140
Selecting a Subject, 130
Selecting Cc Destinations, 130
Selecting Delivery Destinations, 156
Selecting Destinations, 128
Selecting destinations
 Ridoc Document Router/Pro/Lt, 156
 Sending scanned image files (FTP), 150
 Sending scanned image files (SMB), 140
Selecting Destinations and a Subject
 E-mail, 128
Sender, 124
Sending a Scanned File to a Registered
 Shared Folder
 Procedure Breakdown, 139
Sending scanned image files (FTP)
 File names, 152
Sending scanned image files (SMB), 140
 File names, 147
Sending scanned image files to
 unregistered shared folders
 Procedure Breakdown, 143
SSID, 189
Starting a Scan Operation, 135

T

To start with originals in the ADF, 135
TWAIN, 7, 119

U

Using the Enter Custom Send File
 function, 144

W

Warning, 2



Declaration of Conformity

“The Product complies with the requirements of the EMC Directive 89/336/EEC and its amending directives and the Low Voltage Directive 73/23/EEC and its amending directives.”

In accordance with IEC 60417, this machine uses the following symbols for the main power switch:

I means **POWER ON.**

O means **POWER OFF.**

Image Scanner Operating Instructions



QUICK INSTALLATION GUIDE

Please read the Safety Information in the Operating Instructions before using this machine. It contains important information related to USER SAFETY and PREVENTING MACHINE PROBLEMS.

1 UNPACKING THE SCANNER AND CHECKING THE CONTENTS OF THE BOX

1 Check the contents of the box according to the following list. If one some items are missing, please contact your sales or service representative.

- Quick Installation Guide(this sheet)
- CD-ROM
- USB Interface Card
- USB Cable
- Power Cord
- Tools
- Control Panel Unit

- Screw
- Safety Instruction Sheet
- Card slot cover
- Ferrite Core (Europe only)

2 Remove the plastic bag. Lift the scanner and move it to the place where you want to install it.

2 WHERE TO PUT THE SCANNER

The Scanner's location should be carefully chosen because environmental conditions greatly affect its performance.

⚠ WARNING

- Confirm that the wall outlet is near the machine and freely accessible, so that in event of an emergency, it can be unplugged easily.
- Only connect the machine to the power source described on this sheet.
- Avoid multi-wiring.
- Do not damage, break or make any modifications to the power cord.
- Do not place heavy object on it, pull it hard or bend it more than necessary. These actions could cause an electric shock or fire.

⚠ CAUTION

- Keep the machine away from humidity and dust. A Fire or an electric shock might occur.
- Place the machine on a strong and level surface. Otherwise, the machine might fall and cause personal injury.
- If you use the machine in a confined space, confirm that there is a continuous flow of air.

2 Environments to Avoid

⚠ Important

- Locations exposed to direct sunlight or strong light
- Dusty areas
- Areas with corrosive gases
- Areas excessively cold, hot, or humid
- Locations near an air conditioner or humidifier
- Locations near other electronic equipment
- Locations where the scanner might be subjected to frequent strong vibration

3 Power Connection

Connect the power cord to a power source with the following specifications:

Product Specifications

North America	G421-17 power supply rating: AC 120V, 60Hz, 2A
Europe/Asia	G421-27 power supply rating: AC 220-240V, 50/60Hz, 1A

Electrical Outlet Requirements

North America	G421-17 Electrical Outlet Requirements: AC 120V, 60Hz, min.10A
Europe/Asia	G421-27 Electrical Outlet Requirements: AC 220-240V, 50/60Hz, min.5A

4 Space Required for Installing the Scanner

Leave enough space around the scanner. This space is necessary to operate the scanner. The recommended(or minimum)space requirement is as follows.

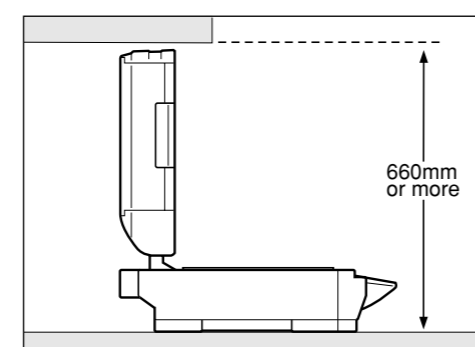
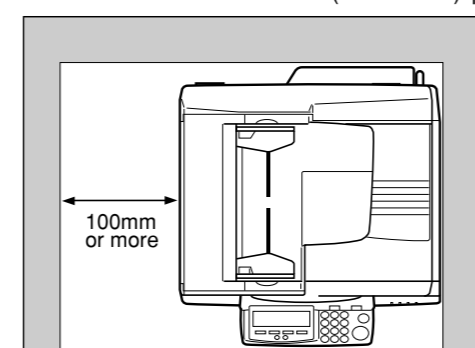

3 INSTALLING THE SCANNER

⚠ CAUTION

- This product weighs approximately 29kg.
- To lift this product, hold the grip at the center of both sides with 2 people and lift slowly not to inflict too much burden on the carriers body. Forcing yourself too much to lift or handling this product recklessly may lead to injury.

1 Take out the scanner main unit.

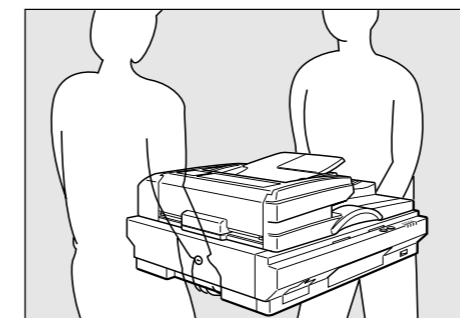

2 Remove the tape (① through ④).

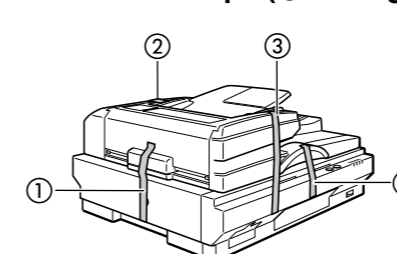

3 Open the automatic document feeder(ADF) and remove the protective sheet on the exposure glass.

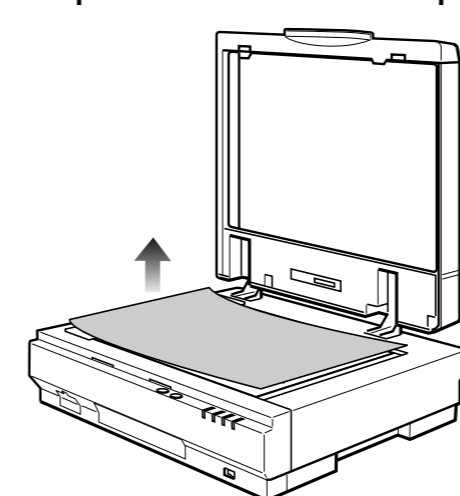

4 DISENGAGING THE LOCK

1 Set the lock switch on left side of the scanner to the "Unlock" position.

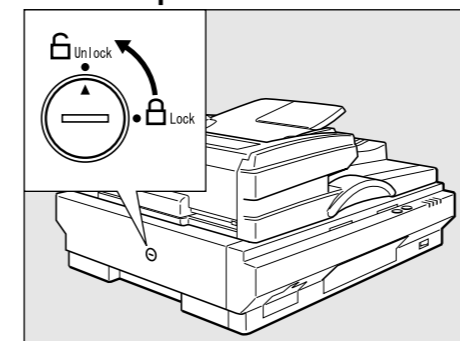

5 Attaching the Control Panel Unit to the Scanner Unit

Note

- Use the tool that comes with this machine when you tighten or loosen the screws.

1 Insert the plug of the control panel unit into the connector of the scanner unit, as illustrated below.

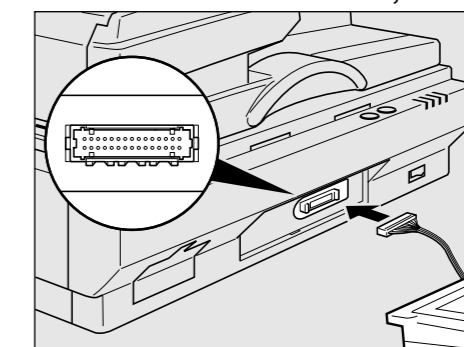

⚠ Important

- While making sure that the plug is facing in the correct direction, insert the plug as far as it goes into the socket. It may be a bit tight to insert the plug into the socket, so push the plug with a strength that is enough for inserting it in place.

Note

- To avoid the plug being inserted in the wrong direction, the connector has a number of tiny prongs inside and outside of it. When you insert the plug into the connector, make sure that the connector is facing in the correct direction. Inserting in the wrong direction creates the risk of damage to the plug and the connector.
- Be careful not to pinch the cable when you attach the control panel unit to the scanner unit.
- Locating the scanner unit at an end of a desk makes it easy to attach the control panel unit.

2 Insert the hooks of the control panel unit to the scanner unit.

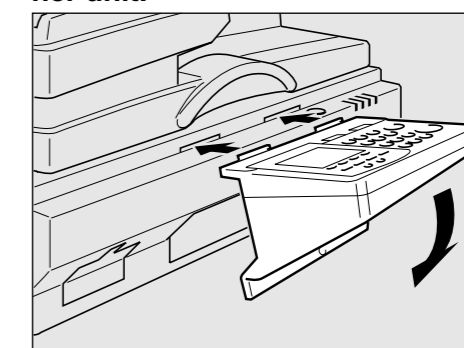

3 Secure the control panel unit using the screw that comes with this machine.

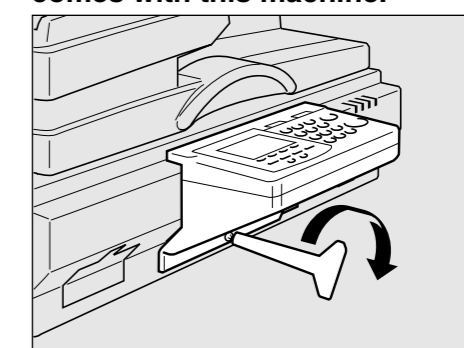

Note

- Do not open the cover located at the lower left of the control panel. Changing configuration of the switches inside of the cover could cause this machine to stop operating normally.

1 Optimum Environment Conditions

Recommended temperature and humidity

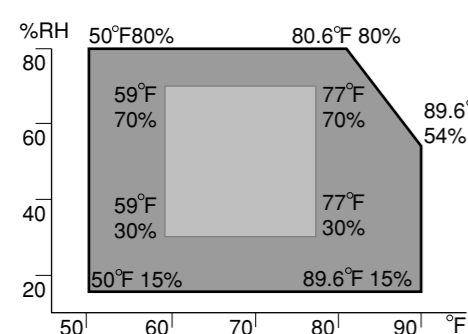
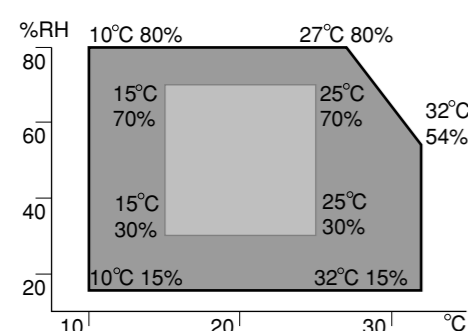

■ Possible operation range ■ Recommended range

The machine must be level within 5 mm, 0.2" both front to rear and left to right.

6 Connecting to a Network

This section explains how to connect this machine to a network.

Important

- Use a 100BASE-TX (category 5) or 10BASE-T network cable when you connect this machine to a network.

- With the network cable you use for connection, create a single loop about 15cm (6") away from an end of the cable, and then attach the ferrite core that comes with this machine as illustrated below.

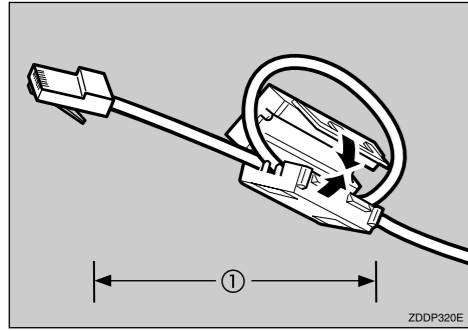

Note

- Skip this step when you use this machine in North America.

- Insert the network cable's end that has the ferrite core into the network interface connector of this machine.

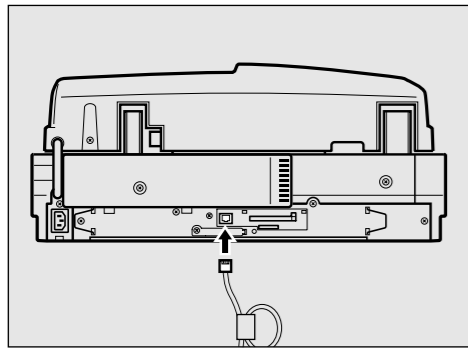

- Insert the other end of the network cable into an appropriate connector of a network device, such as an Ethernet hub.

7 Connecting to a Local Printer

You can make a USB connection between this machine and a printer, when you want to use it as a local printer for Print Scan. This section explains how to connect a printer to this machine using a USB cable.

Note

- When you connect a local printer to this machine, be sure to use the USB cable that comes with this machine.
- See the manuals that come with the printer you are going to connect to this machine, for details about the printer's connections and setup information.

- Turn off the power of this machine.

- Insert the USB interface card that comes with this machine to the PC Card slot on the rear panel of this machine.

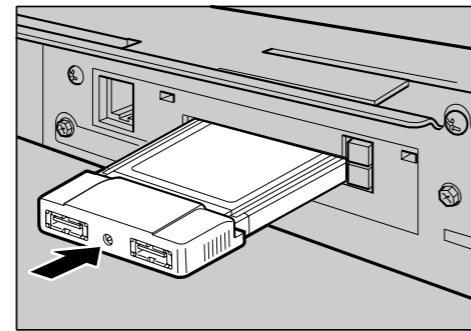

Note

- Make sure that the card is securely inserted, until you feel the card click into place.

Important

- If you remove the USB interface card while the machine's power is on, it is necessary to restart the machine.

- Connect a USB cable to one of the USB ports of the USB interface card.

- Connect the other end of the USB cable to the USB port of the printer.

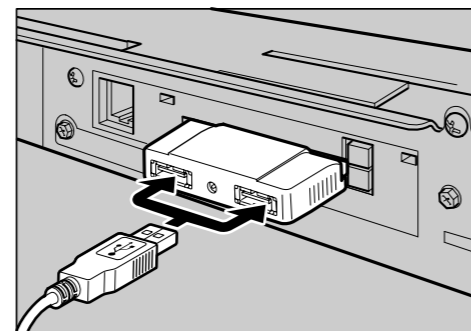

Important

- You cannot use more than one printer as a local printer for Print Scan at the same time. When you connect two or more printers to the machine using USB cables, the printer that is detected by this machine first is only available.

- Attach the card slot cover that comes with this machine.

To attach the card slot cover

- Reeve the USB cable through one of the slits of the card slot cover.

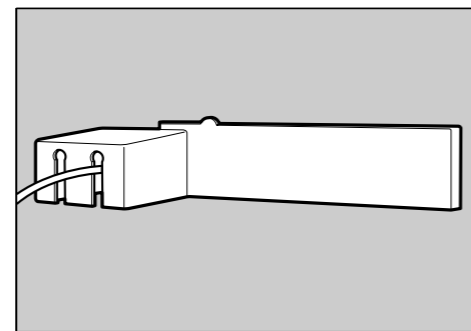

Note

- When you connect two printers to this machine, reeve one of the USB cables through a slit, and the other USB cable through the other slit.
- This step is not necessary when you use an optional wireless LAN card instead of the USB interface card.

- Align the two prongs of the card slot cover with the two prong holes located at the upper left and right of the PC card slot.

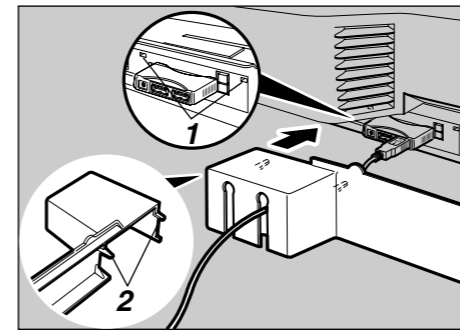

- Prong holes
- Prongs

- Insert the prongs to the prong holes, and then push both sides of the card slot cover until it is secured to the rear panel of this machine.

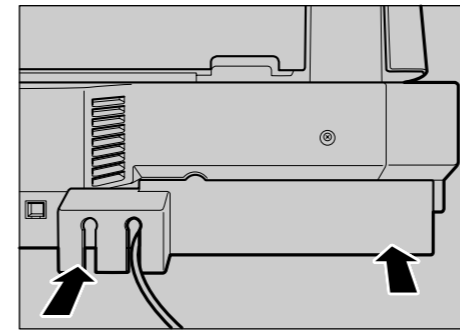

8 Connecting to a Power Source

This section explains how to connect this machine to a power source, using the bundled AC power cord.

WARNING

- Do not use with a power source with a voltage different from the specified voltage. Do not use a power outlet with multiple devices plugged in. These could create the risk of fire or electric shock.
- Avoid the use of an extension cord.
- Do not damage, break, twist or modify the Power Cord. Placing heavy objects on the cord, pulling on or bending it excessively can damage the Power Cord, creating the risk of fire or electric shock.
- Never touch or unplug the power plug with wet hands. This can create the risk of electric shock.

CAUTION

- When unplugging from an outlet, be sure to grasp the plug when pulling. Never pull on the cord. This could damage the cord creating the risk of fire or electrical shock.

- Confirm that the power switch is set to off.

- Confirm that the lock switch located on the left side of the machine is set to the "Unlock" position.

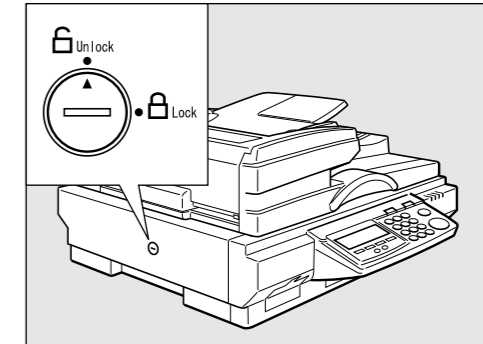

Important

- Be sure to set the lock switch to "Unlock". Turning on the power with the lock switch set to "Lock" could result in failure in scanning or malfunction of this machine.

- Push the power cord plug all the way into the power connector on this machine.

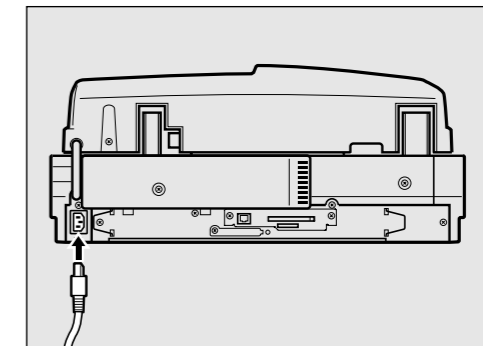

Note

- Be sure to use the power cord that comes with this machine.

- Insert the power plug into the power outlet.

Before turning off the power

Before you turn off the power of this machine, make sure that a standby screen is displayed on the display panel.

If you turn off the power while the scanner features menu is displayed, all the settings that you have configured could be discarded, and this machine could return to its factory default status.

You should also confirm that the power indicator is not lit, when you turn off the power. Otherwise, loss of scan data or failure in sending files might occur.